

Installation Manual

200 Series



AHE-250-D01



Contents

Caution Notes.....	1
Introduction	2
System Features	4
Component Cut-Aways	5
Installing the 250D	6
Support and Clearance.....	7
Installation of the Expansion Bottle.....	9
Heat Exchanger Layout.....	10
Installing Heat Exchangers.....	11
Mounting the Heat Exchangers.....	12
Heat Exchanger Locations and Clearances.....	13
Wiring the Heat Exchangers	14
Wiring the Zone Thermostats	14
Plumbing the Heating Zone.....	15
Domestic Water System Requirements.....	17
Plumbing the Domestic Water System	17
Interior Switch Panel.....	18
Diesel Fuel System.....	20
Exhaust System.....	23
Pin-Out Information.....	26
Connecting the 250D to 12V DC Power	27
Connecting the Aqua-Hot to AC Power	28
Filling/Purging the Aqua-Hot 250D.....	29
First Operation.....	30
Winterizing.....	31
Appendix A: System Schematics	32
Appendix B: Measuring Antifreeze.....	33
Appendix C: Parts & Accessories	36
Warranty	43

Caution Notes

As you read this information, take particular note of the NOTICE, CAUTION, WARNING, and DANGER symbols when they appear. This information is important for safe and efficient use of the Aqua-Hot system.

NOTICE signals a situation where potential damage to the Aqua-Hot could occur.

NOTICE

CAUTION signals a situation where potential harm or risk of minor or moderate injury could occur if you do not follow instructions.

CAUTION

WARNING signals a hazardous situation where potential harm, risk of serious injury, or death could result if instructions are not followed.

WARNING

DANGER signals a situation where immediate risk of serious injury or death will result if instructions are not followed.

DANGER

NOTE: This manual will also use notes sections similar to this one to draw attention to features and practices which must be observed.

Read all instructions before installing the Aqua-Hot unit. Aqua-Hot Heating Systems is not liable for damage resulting from failing to follow instructions contained in this, and any other Aqua-Hot documentation relevant to this unit.

- Read this manual before installing or using the Aqua-Hot System to reduce the risk of injury to persons or damage to the equipment.
- The product identity label contains specifications of the unit, to what standards it has been tested, and important safety notices.
- The Aqua-Hot must be installed in a compartment that is closed off from living quarters and accessible only from the exterior of the vehicle.
- **Propylene glycol** based antifreeze “Generally Recognized As Safe” (GRAS) by the FDA must be utilized for the antifreeze and water heating solution.
- An interlock switch prevents the Aqua-Hot heater from operating when the cover is not installed in the correct position.
- Disconnect electric wiring to the Aqua-Hot System before welding or plasma cutting the coach to avoid damage to equipment.
- The Aqua-Hot tank and heating loop operate at 0.0 PSI (zero pressure system). Air pressure to the tank must not exceed 20 PSI. Exceeding this rating will cause internal damage to the Aqua-Hot.
- Use caution when working on or near any fuel system.
- Do not store or use gasoline or other flammable vapors or liquids in the vicinity of this or any other appliance.
- The Aqua-Hot’s exhaust is HOT and must be kept away from heat sensitive material.
- DO NOT connect the 12-volt DC power to the Aqua-Hot if the vehicle requires welding.
- At maximum operating temperature, the coolant will be very hot and scalding. Hot vapor or coolant may cause in serious burns or injury. Be aware of hot surfaces.
- Do NOT activate the burner until the antifreeze and water heating solution has been added to the boiler tank to avoid serious damage to the heater.
- Installation and repairs may only be carried out by an authorized, factory-trained Aqua-Hot technician. The heating system must be installed in accordance with local codes, or in accordance with the Standard for Recreational Vehicles, (RVIA) ANSI A 119.2/NFPA 501C, NFPA 1192.

WHAT TO DO IF YOU SMELL GAS



- Evacuate all persons from the vehicle.
- Shut off the gas supply as the gas container or source.
- Do not touch any electrical switch or use any phone or radio in the vehicle.
- Do not start the engine or electric generator (if equipped).
- Contact the nearest gas supplier or qualified service technician for repairs.
- If you cannot contact the nearest gas supplier or qualified service technician, contact the nearest fire department.
- Do not turn on the gas supply until the gas leak or leaks (if relevant) have been repaired.
- Installation and service must be performed by a qualified installer, service agency, or gas supplier.

The Aqua-Hot’s exhaust is HOT!

- Do NOT park in areas where dry conditions exist (IE grassy, dry fields).
- Do NOT operate the burner inside an enclosed building.
- The heater must be switched OFF when refueling.

NOTE: Should any additional assistance be needed, please contact the Technical Support Department at 574-AIR-XCEL (574-247-9235).



About the Aqua-Hot 200 Series

The Aqua-Hot 250 Diesel Series Hydronic (water-based) heating systems provide interior heat and tank-less continuous hot water in one small, easy to install package.

The heating system provides moist, quiet, comfortable interior heat. The Aqua-Hot is equipped with one thermostatically controlled temperature zone.

The tank-less hot water system produces 90 gallons per hour (1.5 GPM) of continuous hot water.

These TribridHot™ Systems use one or a combination of heat sources to heat FDA-approved “Generally Recognized As Safe” (GRAS) **propylene glycol** based antifreeze solution in the Aqua-Hot’s boiler tank.

The heater also employs a 12V DC diesel burner as the primary heating source. The burner should be used for continuous hot water and interior heating in cold conditions. In addition to the burner, the 250D Series model also employs an electric heating element as a *supplemental* heating source. Once the tank has reached temperature by way of the 12V DC diesel burner, the electric element may be engaged to provide light-duty hot water and heating needs, and serves to maintain tank temperature during periods which the heater is not in used. For continuous hot water and heat in cold conditions, the diesel burner **must** be active.

Should additional assistance be needed, please contact the Product Application Department at 574-AIR-XCEL (574-247-9235) Monday through Friday, 7am to 4pm Mountain Standard Time.

System Overview

The Aqua-Hot 250 Diesel Series is a Hydronic Heating System that can provide heat and hot water on demand using a built-in electric heating element and a diesel burner.

The Aqua-Hot Heating is a 2-in-1 System

1. Interior heating system: provides quiet, comfortable interior heat and even temperatures.
2. Tank-less hot water system: provides a flow of continuous hot water.

The Aqua-Hot heating system heats an **propylene glycol** based antifreeze and distilled water solution that is stored in the Aqua-Hot’s boiler tank. This fluid solution must be up to operating temperature before the Aqua-Hot will provide interior heat or hot water. The tank-less hot water system produces approximately 1.5 GPM of hot water.



For installation only in a compartment that is completely closed off from living quarters and accessible only from the outdoors.

Exhaust system MUST NOT terminate beneath the vehicle and not less than 3 feet from an openable window.

Combustion Air MUST BE supplied from outside the vehicle.

Suitable for water (potable) heating and space heating.

THIS APPLIANCE OPERATES ON BOTH DC AND AC POWER.

USE COPPER CONDUCTORS ONLY!

Use a circuit breaker that cuts power at 20-Amps maximum for over-current protection for the 120-VAC power supply.

Mount the Heater near a bay-storage door so that the Access cover can be easily removed for service.

For Detailed Information, reference the Owner's Manual or contact Aqua-Hot Heating Systems Inc. at 574-AIR-XCEL (574-247-9235).

Minimum Service Clearances

- Front - Open Access
- Back - 1 Inches
- Top - 8 Inches
- Sides - 1 Inches

This appliance must be installed in accordance with local codes or, in the absence of local codes, the Standard for Recreational Vehicles, ANSI A119.2/NFPA 1192 or CAN/CSA-Z240 RV



For Direct Vent Installation in a Recreational Vehicle.

Meets or Exceeds: **UL 307B, UL 174**
CSA/CAN B140.0-03
CAN/CSA-C22.2 No. 110-94

Max Tank Pressure	0 PSI
Watts (DC)	92.5
Watts (AC)	1000
Tank Capacity	3.7 gal
Orifice Size/Angle	0.35/60°
Volts/Amps	12VDC, 12.2A
Volts/Amps/Frequency	120VAC, 9.6A, 50/60Hz
Pump Pressure	145 PSI/10.0 bar
Input Firing Rate	55,000 BTU/hr, 17.6 kWh
Diesel Burner Model	Aqua-Hot
Fuel Type	Diesel

Diesel Burner Serial Number: DB185555__
 Model Number: 250D
 Serial Number: A250D-XXXXXX

7501 Miller Drive • Frederick, CO 80504 • 574-AIR-XCEL • www.aquahot.com

NOTE: This product label is attached to the side of the Aqua-Hot, and provides a ready reference to specifications, test standards, and important safety notices.



Figure 1

System Specifications

Electric Element

Power Consumption1000 W (maximum)
 Voltage120V AC

DC Power

Heat Input66,000 BTU/hr ± 10%
 Fuel Consumption0.40 gallon/hr
 Power Consumption 108W (maximum)

Zone Heat Circulation

Pumps 1
 Power Consumption (max)..... 21W
 Voltage 12V DC

Heating Zones

Maximum 1

Domestic Water Heating

Maximum 1.5 GPM

Physical Specifications

Dimensions (US).....22.44”L x 12.46”W x 17.2”H
 Dry Weight 84lbs.
 Wet Weight..... 104lbs

All vehicle installations must comply with the requirements listed in the Recreational Vehicle Industry Association's (RVIA) ANSI/NFPA 1192 Handbook for Recreational Vehicle Standards.

- 1. Access Cover Screw
- 2. Drain Valve
- 3. 3-Way Valve
- 4. Tempering Valve
- 5. Diesel Burner Controller
- 6. Diesel Burner Assembly
- 7. Interlock Switch
- 8. Domestic Cold Water Inlet
- 9. Domestic Hot Water Outlet
- 10. 12V DC Harness Junction
- 11. Diesel Fuel Connections
- 12. Expansion Tank Connection
- 13. Heating Zone Return Port
- 14. Heating Zone Outlet Port
- 15. AC Relay Enclosure
- 16. 120V AC Connection
- 17. Boiler Tank
- 18. Domestic Hot-Water Coil
- 19. Zone Circulation Pump

NOTE: The side and top panels in the view below have been made transparent to aid in the explanation of the heater. DO NOT remove these panels. Doing so risks irreparable damage to the Aqua-Hot. Only remove the service panel for service.

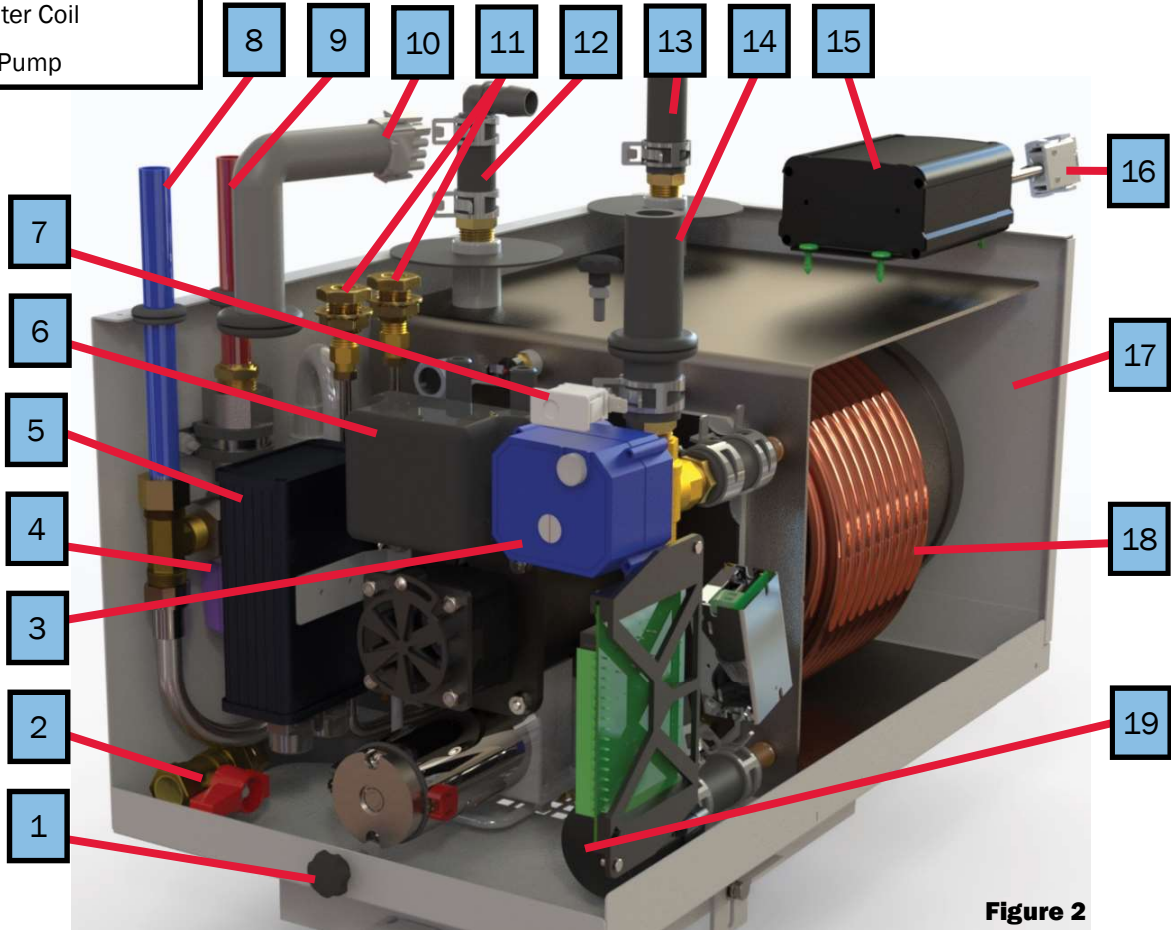

Figure 2

Installing the 250D

Install the Aqua-Hot in a compartment which protects the unit and allows service access to the top and front panel of the Aqua-Hot. The Aqua-Hot must be installed in a compartment that is completely closed off from living quarters and accessible only from the exterior.

1. Reference the following illustrations below for mounting information.
2. Cut out the required mounting flange opening Reference Figure 4.
3. Install the flange located on the bottom of the Aqua-Hot into the cutout opening. Reference Figure 6 & 7.
4. Take the angle brackets and included 1/4-20 bolts and washers. Install the angle brackets into the nuts located on the flanges.
 - Front view Aqua-Hot dimensions Figure 3.
 - Floor cutout information Figure 4.
 - ID Label noting the front and service access clearance requirements Page 4.

NOTE: Inspect the area beneath the mounting location to ensure that no structural members will interfere with the cutout for the mounting flange. Verify that a support structure of adequate strength has been constructed. Figure 5.

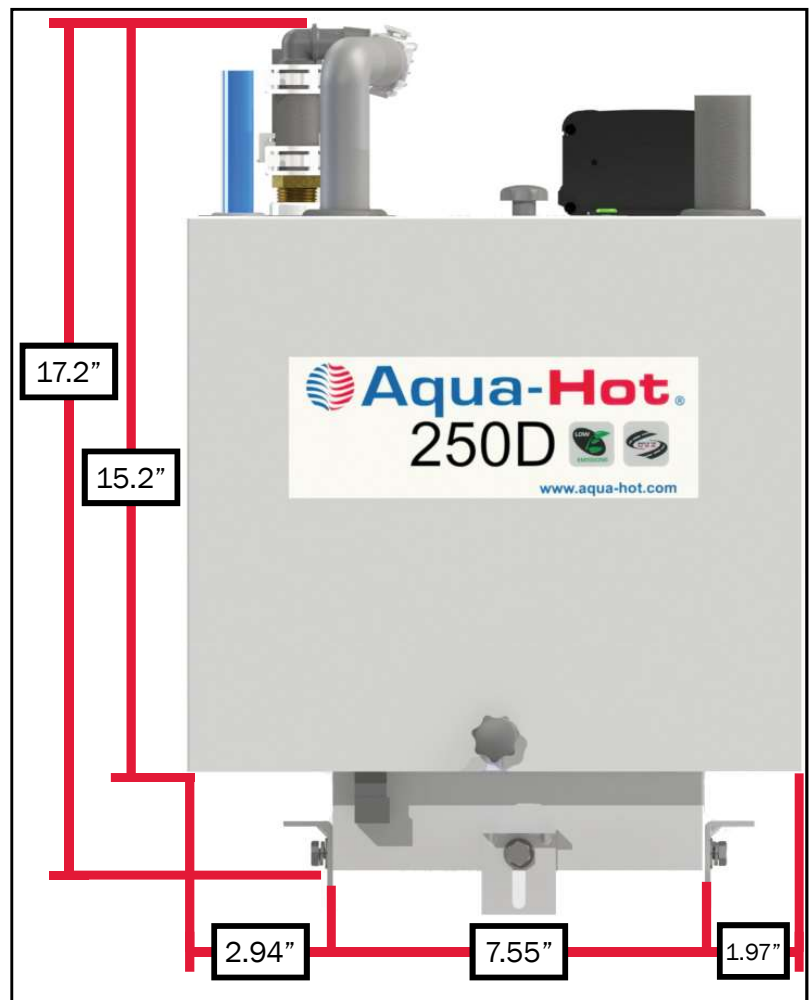

Figure 3

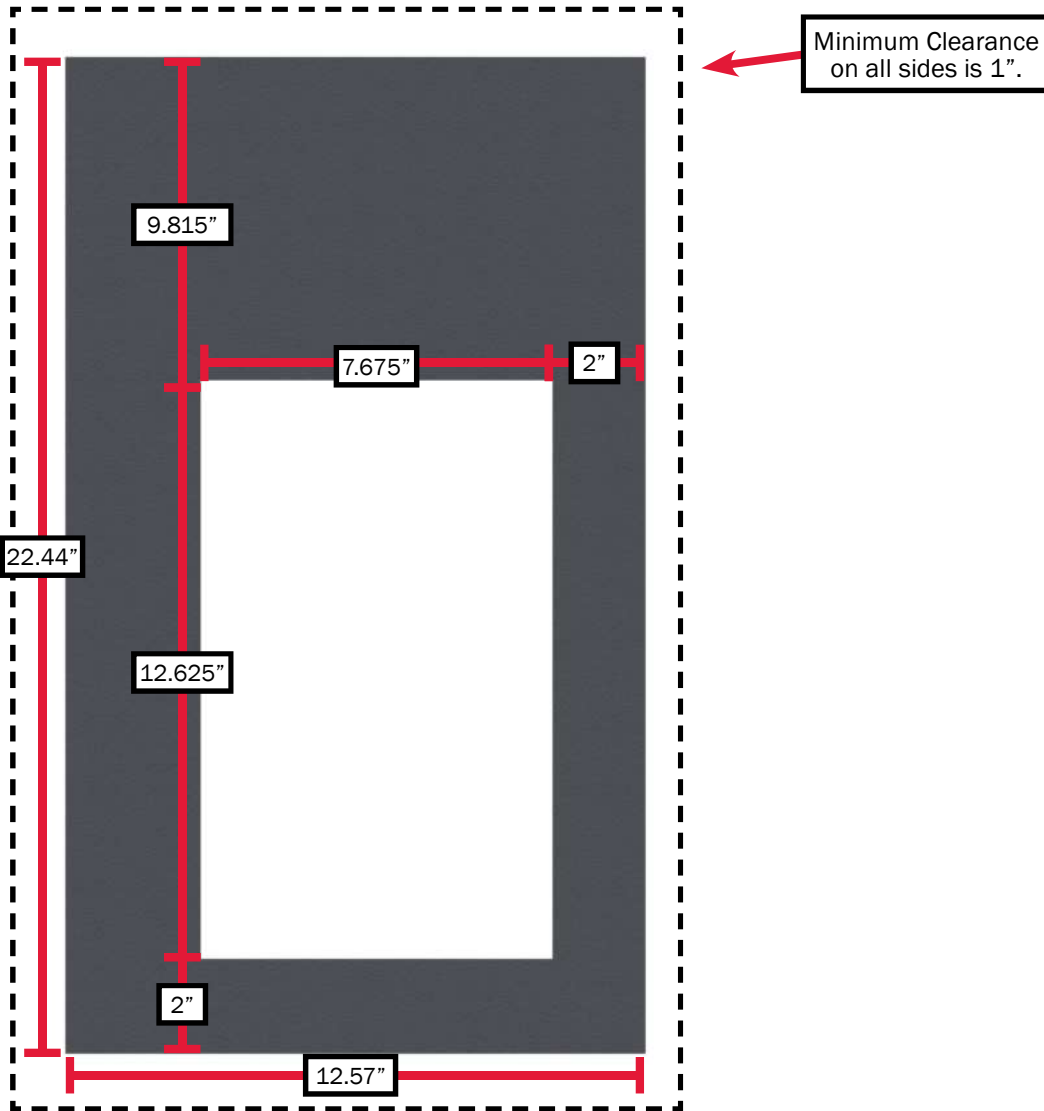

Figure 4

NOTE: The mounting flange of the Aqua-Hot is not centered on the body of the heater. Reference Figure 4 for the correct dimensions to construct the surface on which the Aqua-Hot will be mounted.

Additional cross-members are required if the existing structure is unable to support 104lbs.

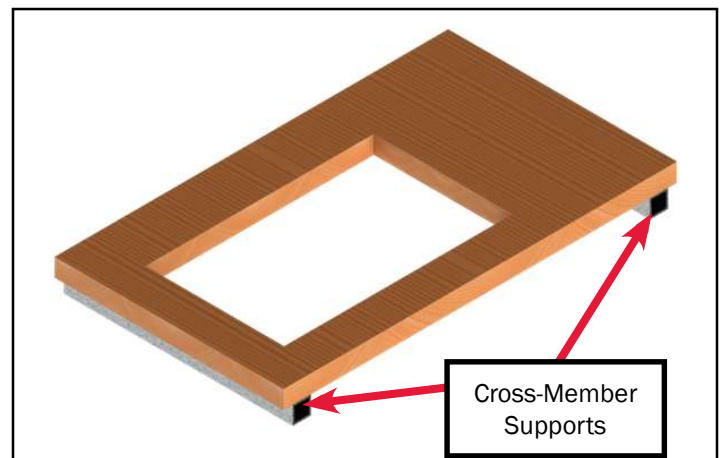

Figure 5

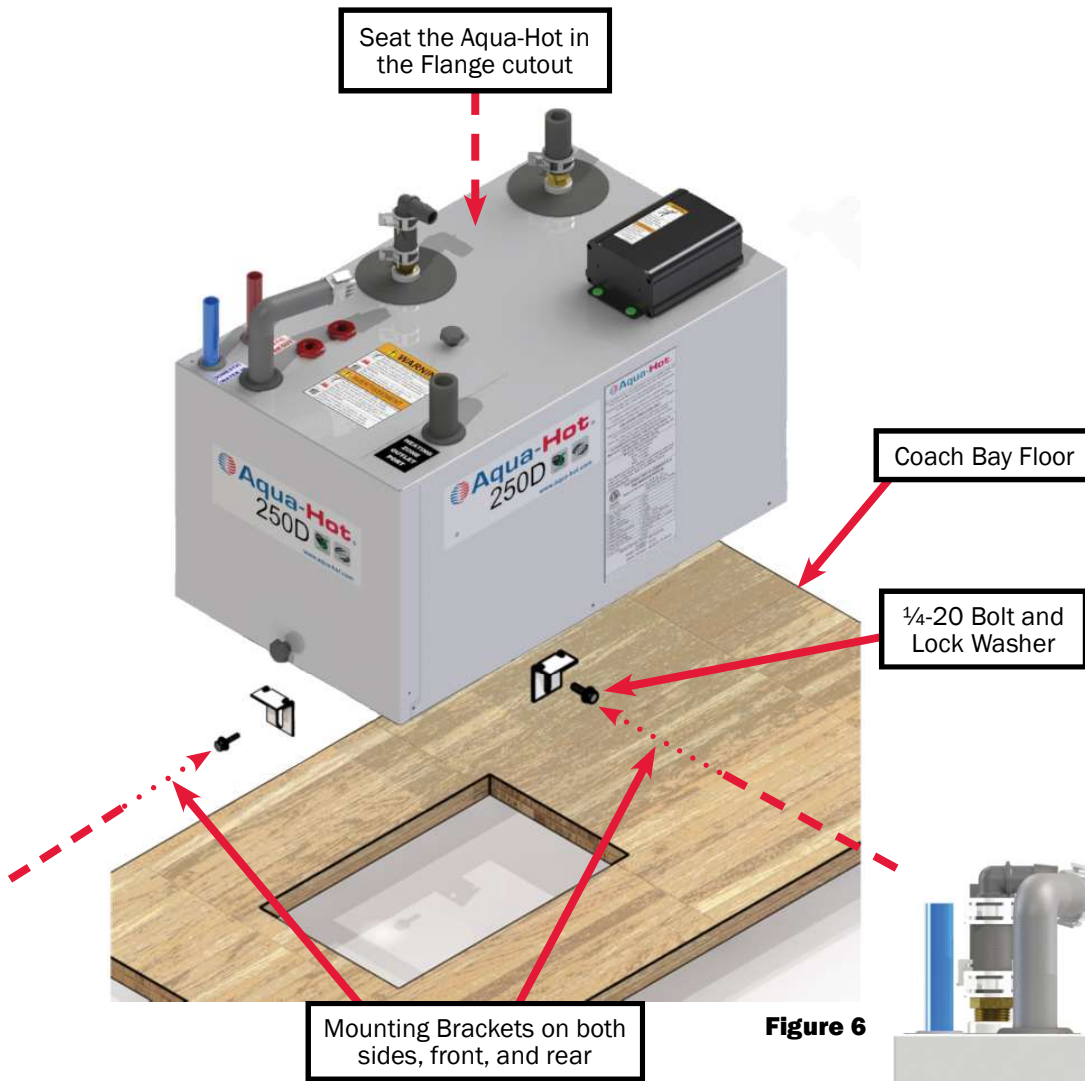

Figure 6



Figure 7

NOTE: Angle mounting bracket must be flush to the underside of the coach floor and flush to the heater flange. Tighten bolts to roughly 76 in.-lbs.

Installation of the Expansion Bottle

Introduction:

The fluid expansion bottle is integral to the operation of the Aqua-Hot. It provides an area for hot, expanded fluid to empty into, and also protects the Aqua-Hot from low-fluid, which could lead to catastrophic damage of the Aqua-Hot.

Follow the directions in this section to correctly install the fluid expansion bottle.

Installation Procedure:

1. Select a mounting location that allows for easy access and clear visibility whenever the storage bay containing the expansion bottle is open.
2. Mount the expansion tank as illustrated in Figure 10.
3. Connect and clamp the overflow tubing from the expansion tank to the Aqua-Hot's expansion tank connection.
4. Drill a hole in the bay floor and cut a piece of overflow tubing (included with unit) of adequate length so that it can be connected to the top of the expansion tank and extend through the bay floor. The expansion hose should vent to the exterior of the Aqua-Hot bay.
5. Locate the wire leads exiting the expansion bottle.
6. Connect these wires to wires #10, #15, and #16 on the Aqua-Hot wiring harness. Note that wires #10 and #15 will co-terminate in a single jacketed connector as shown in Figure 9.
7. Once complete, secure these wire leads to minimize risk of accidental damage.

NOTE: Avoid any bends or dips in the overflow tubing from the Aqua-Hot. Air can become trapped in these bends and will prevent excess antifreeze and water heating solution from depositing properly in the expansion bottle.



CAUTION

The Aqua-Hot tank and heating loop operate at 0.0 PSI (zero pressure system). Air pressure applied to the tank **MUST NOT** exceed 20 PSI. Excess pressure will result in internal damage.

Fluid Level Sensor Wiring Connections



Figure 9

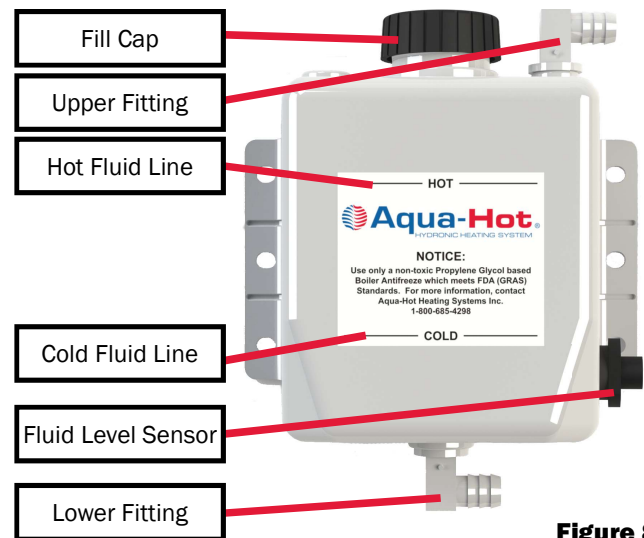

Figure 8

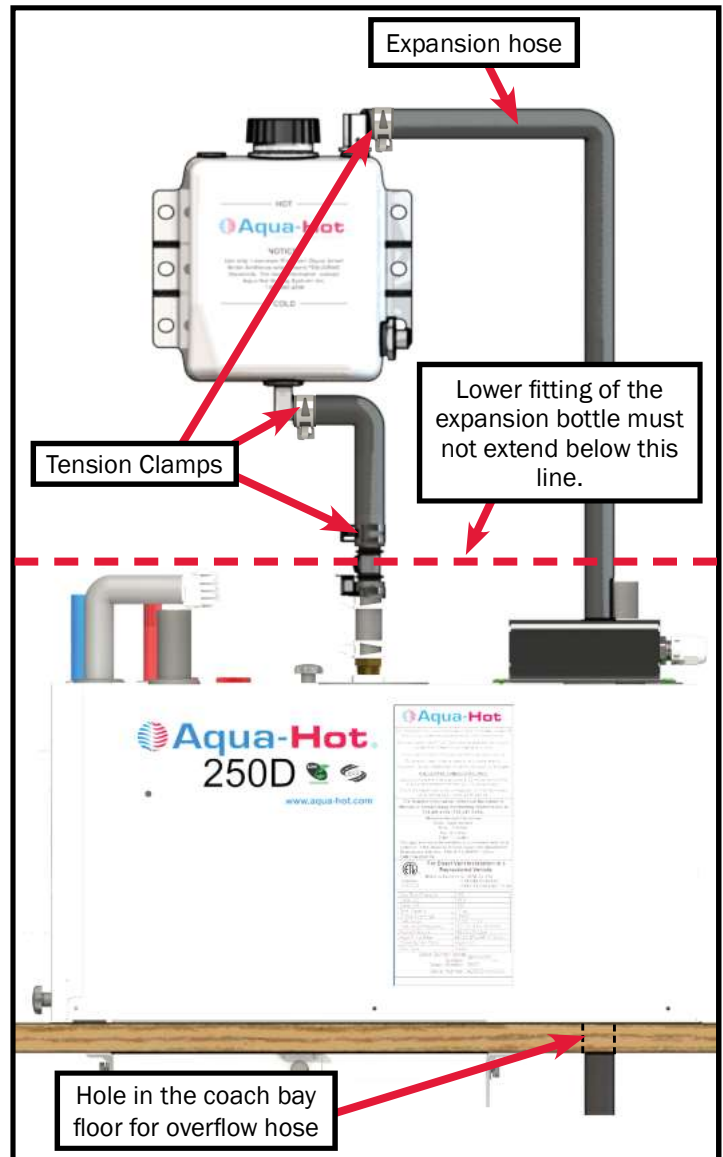

Figure 10

Heat Exchanger Layout

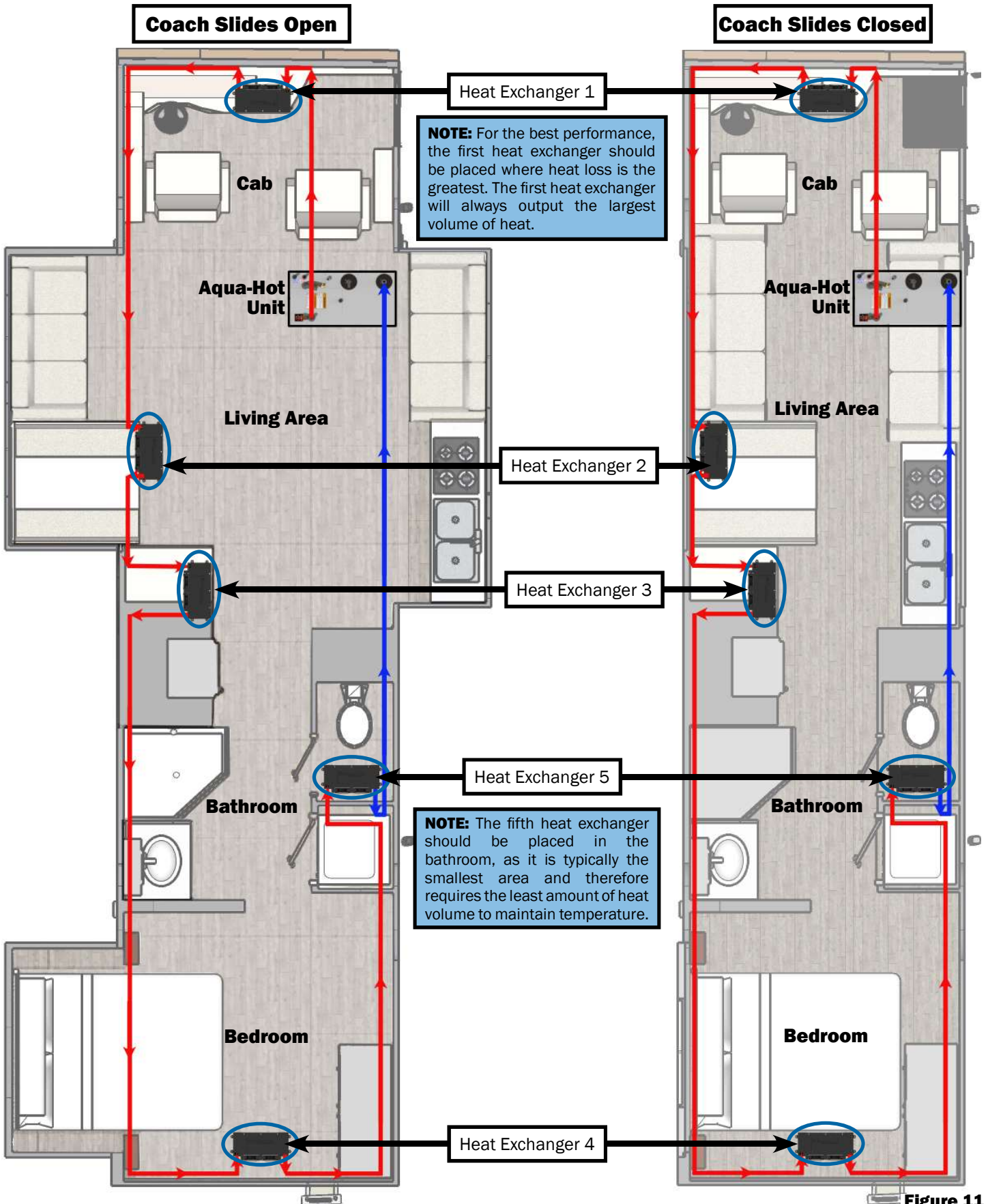

Figure 11

Installation Requirements

Cozy heat exchangers can be mounted in one of two configurations: either flat on the ground, or vertically. Reference Figure 12.

- Supply ventilation cross-sectional area of at least 29in² (74cm²) must be supplied to each heat exchanger.
- Do not supply heat exchangers air which is drawn from the bay areas.
- Return air should be drawn from the same room the heat exchanger is heating.
- The anti-freeze and water heating solution must flow in through the bottom of the heat exchanger, and out the top (reference Figure 23).

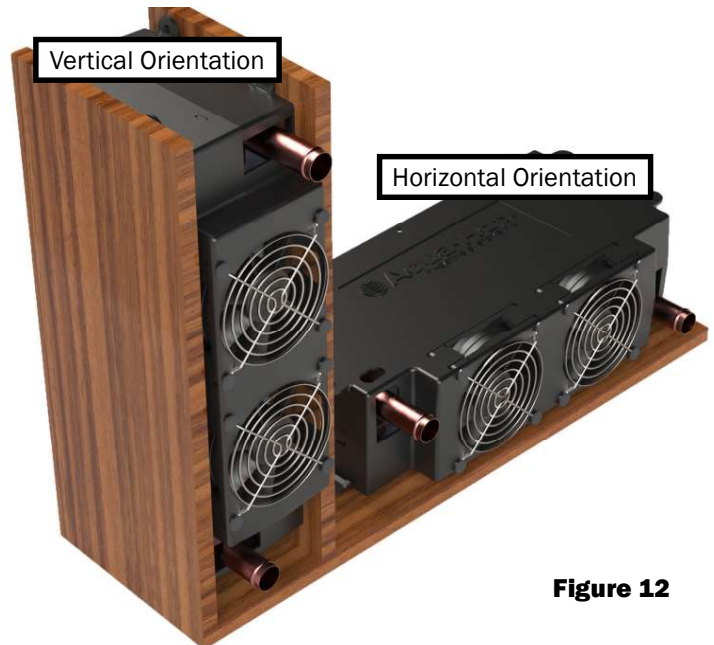

Figure 12

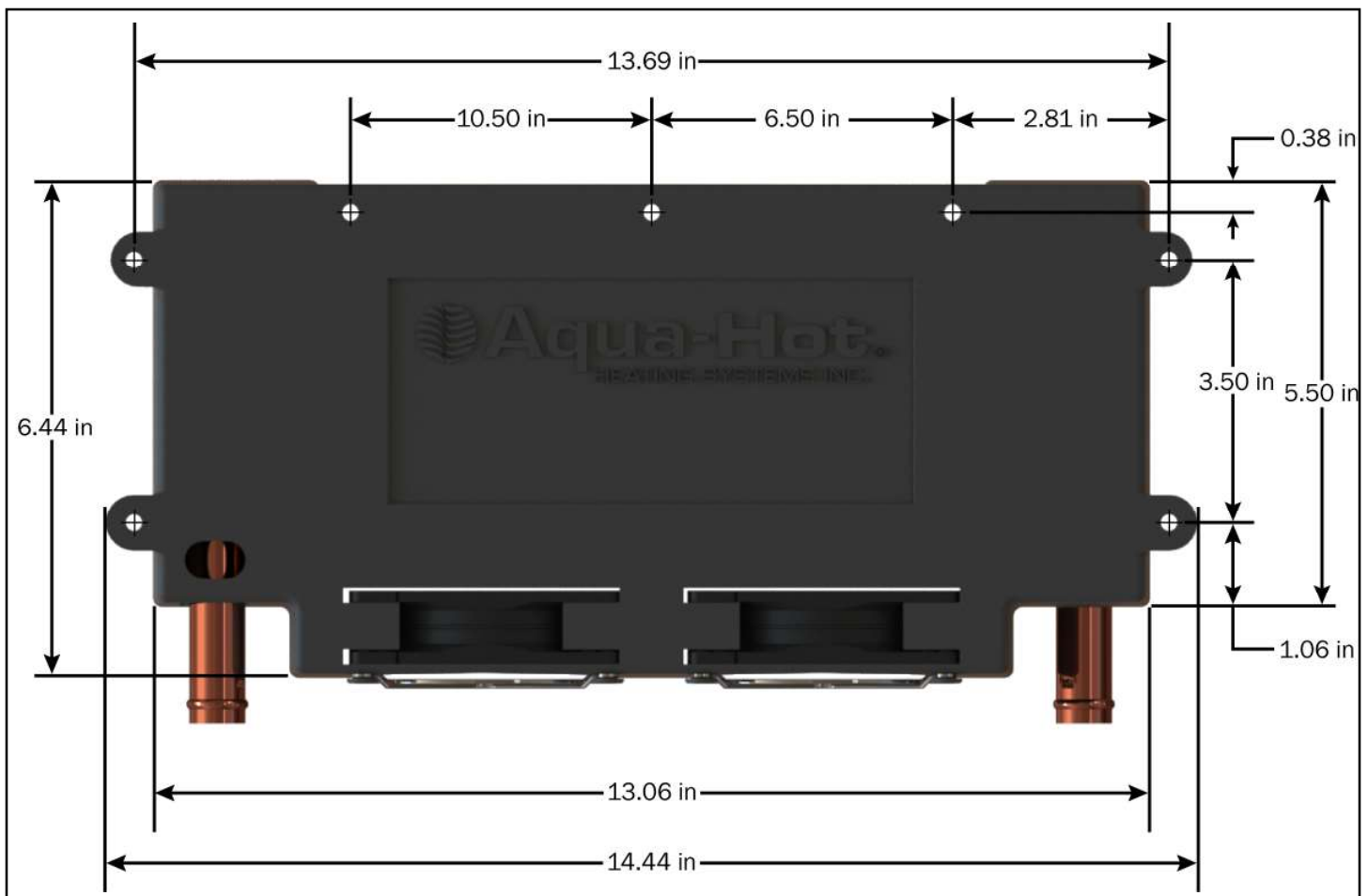

Figure 13

Mounting the Heat Exchangers

1. Cut out a 2.5" x 10" (7cm x 26cm) opening for each heat exchanger outlet and cold-air return grate as shown in Figure 15.
2. Mount each heat exchanger permanently into place. There are 4 tabs on both sides - see Figure 23.
3. Install the hot-air outlet and cold-air return grate. Figure 15.

A minimum of supply ventilation cross-sectional area of at least 29in² (74cm²) must be supplied to each heat exchanger. Please note that a return-air register may not be required, however, adequate return air must be provided to the heat exchanger or you may experience diminished performance of the heat exchanger unit.

If the toe-kick area is inadequate to house a heat exchanger for regular installation, a plenum assembly may be purchased to redirect air via ducting. The plenum allows only the desired outlets to be opened by removing the metal insert on the vent. Refer to Figure 14 & 16.

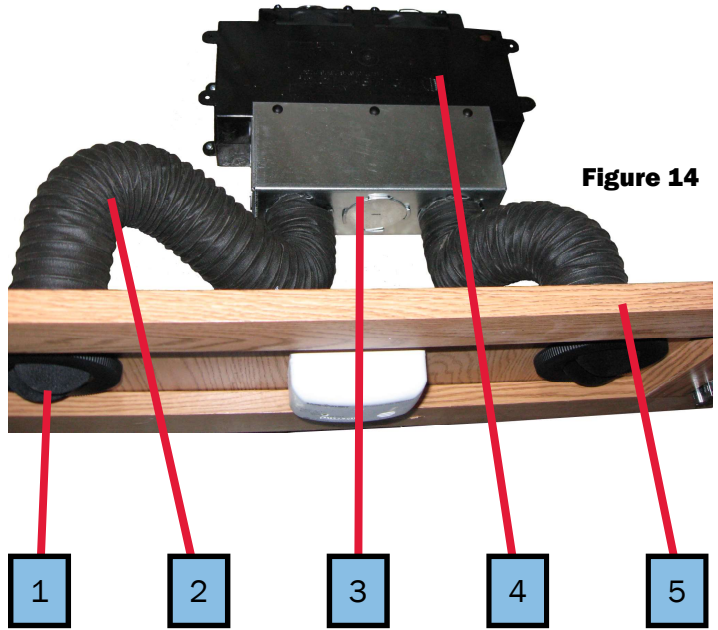

Figure 14

1. Hot Air Outlet Vent
2. Air Ducting Hose
3. Plenum
4. Cozy Heat Exchanger
5. Toe Kick Board

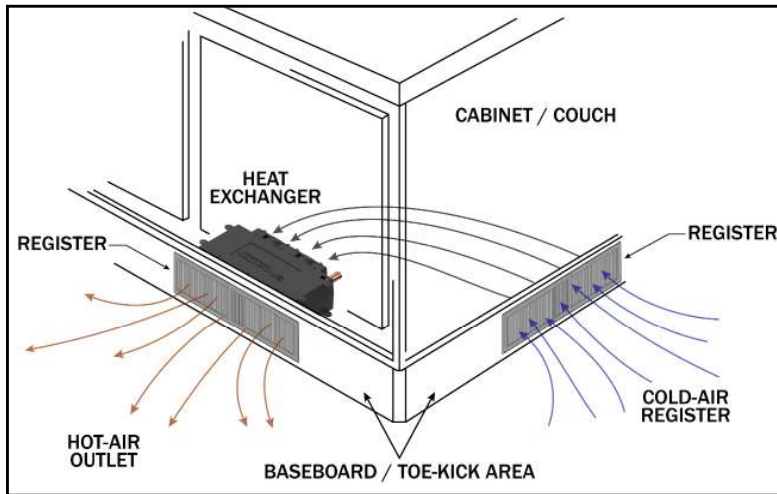

Figure 15



Figure 16

Heat Exchanger Locations and Clearances

NOTE: For single slide-out configurations, it is usually simplest to place a heat exchanger on the opposite side of the coach pointing towards the slide-out.

- Position the heat exchangers so that even heat is distributed throughout the coach interior. Reference Page 10.
- The first heat exchanger on the loop will output the most interior heat.
- It is best practice to place the heat exchanger in an area where it can be easily accessed for maintenance.
- Place the heat exchangers as close to the floor as possible for best performance.
- If a heat exchanger is kept in the fresh water storage bay, then the last heat exchanger in the coolant loop should be used.
- The heating air supply may be fresh or recirculated air that is drawn from a clean area not likely to be contaminated.

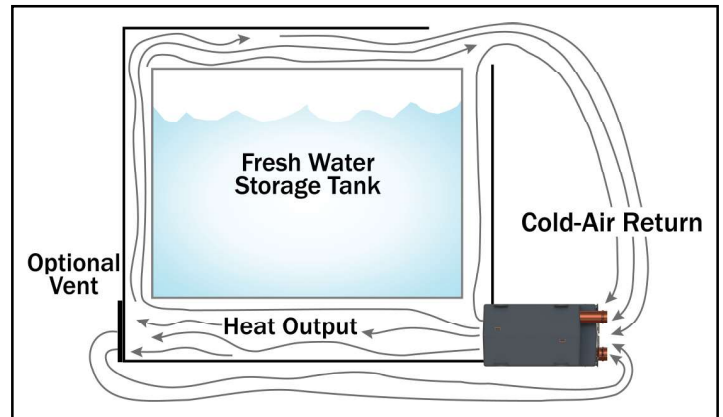

Figure 17

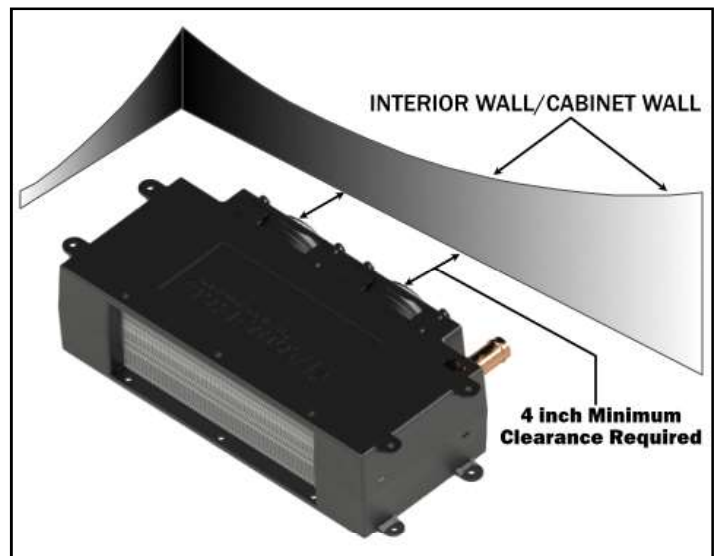
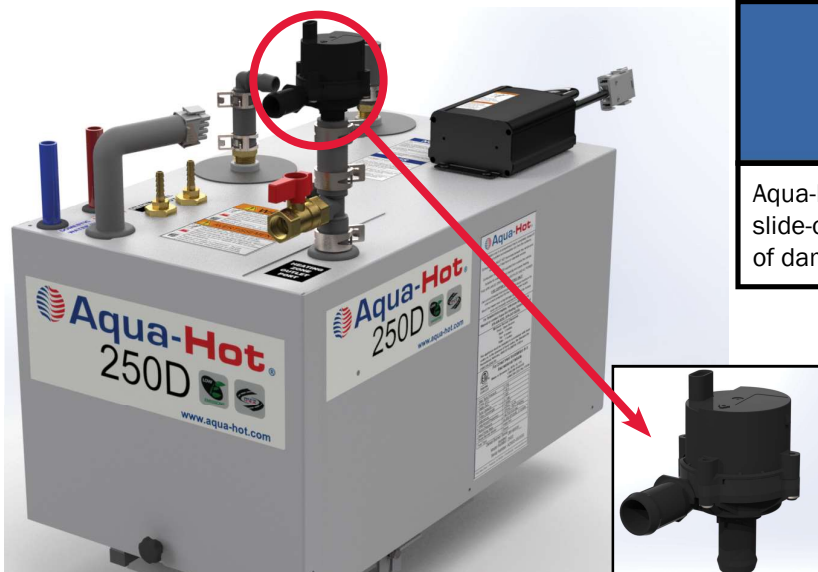

Figure 18

Boost Pump

If desired, a 6th Cozy Heat Exchanger may be added to the heating loop within your coach. Please note, however, that an additional boost pump is required to provide adequate fluid pressure to allow the 6th heat exchanger to operate as intended.



NOTICE

Aqua-Hot advises against placing a heat exchanger on the slide-out section of any vehicle due to the high probability of damage occurring to the heating loop from moving parts.

Figure 19

Wiring the Heat Exchangers

This section will explain in detail how to wire the heat exchangers for optimal functionality. Do not deviate from these guidelines. If a deviation is required, contact Aqua-Hot Heating Systems prior to installing these exchangers for express permission to proceed with modifications.

1. Wire each heat exchanger in a parallel circuit inside the coach (all heat exchangers share a common power wire and a common ground wire) as shown in Figure 21.
2. Run the power wire from the last heat exchanger back to the 8-pin connector and plug it into Pin #7.
3. Run the ground wire from the last heat exchanger back into the 8-pin connector and plug it into Pin #8.
4. With the remaining heat exchangers, tap the power from each exchanger into the previously connected power wire that is running back to the 8-pin connector.
5. Repeat Step 4 with the ground wire.

Wiring for OEM RV-C or Multiplex Control Systems

When choosing a zone control for the heat exchangers, the following guidelines must be adhered to, or the Aqua-Hot will not function correctly in any mode of operation.

- Pin 6 must be supplied with +12V DC to provide power to the coolant circulation pump.
- Pin 7 must be integrated into the OEM control of the zone.
- Pin 7 will be +12V DC when there is a call for interior heat. This +12V DC current will drop when the Aqua-Hot senses domestic water flow.



Wire insertion view shown

Figure 20

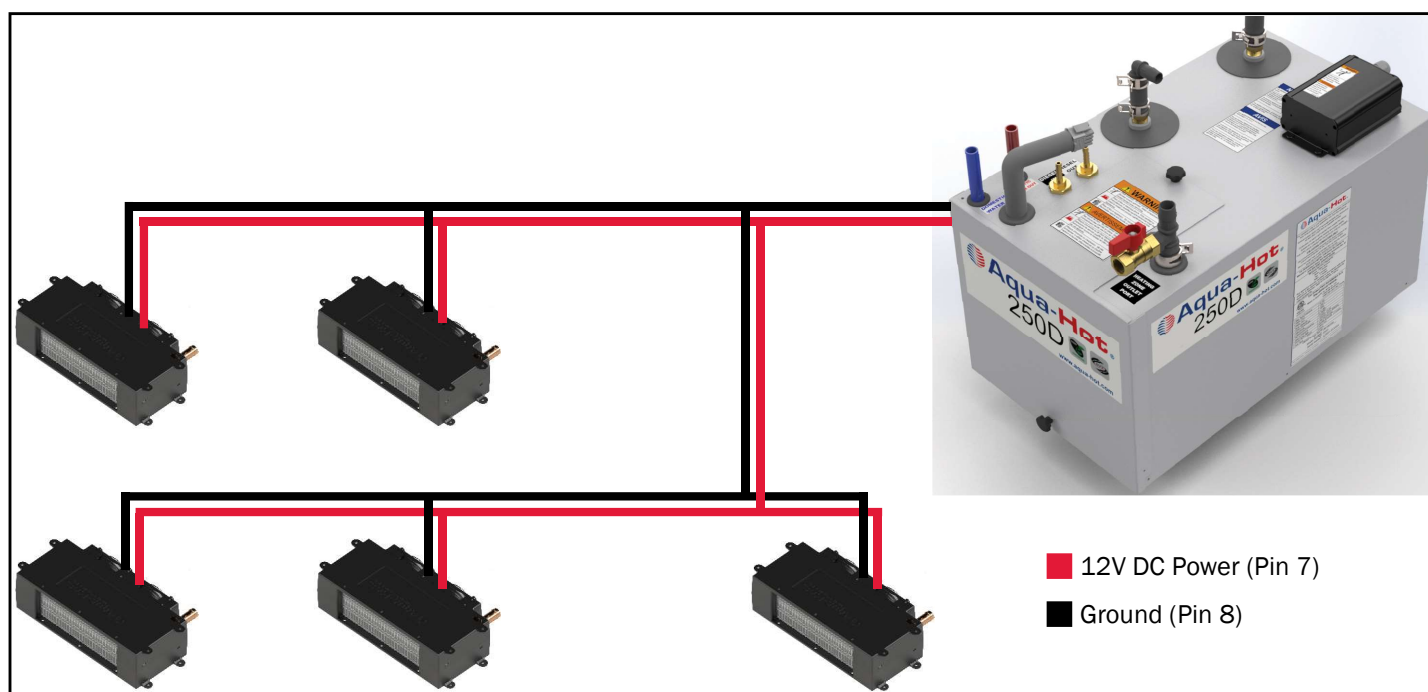

Figure 21

Plumbing the Heating Zone

The following guidelines should be used when planning the coolant loop for the heating zone. The order of the heat exchangers should consider priority on the loop. Failure to adhere to these installation principles can hinder the operation of the heat exchangers.

- All plumbing should be installed as flatly as possible.
- Extreme rises in height should be avoided to avoid any potential air traps.
- Use $\frac{5}{8}$ " ID plumbing lines, $\frac{3}{4}$ " SAE J20 type coolant hose, heater hose, or PEX tubing for the single heating loop.
- Use wide-sweeping elbows or "bend supports" whenever the plumbing lines may be susceptible to kinking.
- When exceeding 5 heat exchangers, a boost pump must be installed in the coolant line to provide adequate pressure to ensure that coolant is distributed throughout the heating loop. See Figure 19.
- Plumbing lines should be run in areas where there is no reasonable possibility that they can be pinched off or damaged under normal operating conditions.
- Secure all lines where necessary and apply protective shielding in areas where chafing may occur.
- Rubber coated/closed-type clamps are recommended when securing the plumbing lines.
- Inlet and outlet plumbing lines can be installed with a straight fitting or an elbow.

Instructions:

1. Layout the plumbing lines for all heat exchangers (see the example in Figure 24).
2. Label each line and designate as an outlet or an inlet line.
3. Connect and clamp the outlet line from the heater to the lowest port (inlet port).
4. Connect and clamp a line from the first heat exchanger's highest port, and connect the other end to the next heat exchanger's lowest point.
5. Connect each additional heat exchanger in the same arrangement.
6. Connect and clamp the inlet line from the heater to the highest port on the last heat exchanger to complete the heating loop.

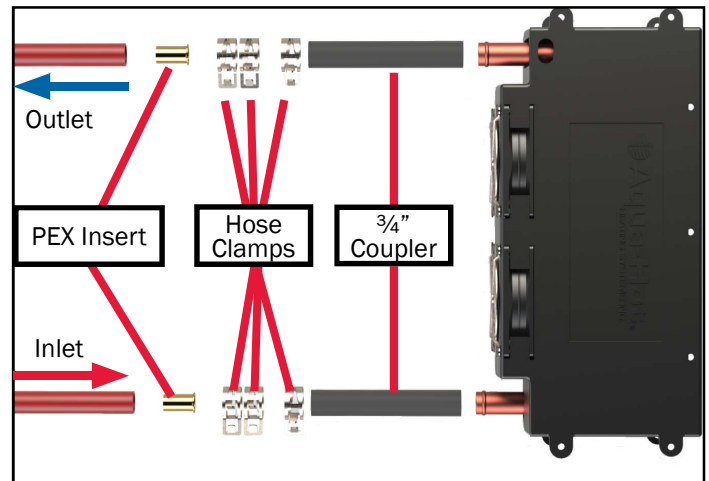

Figure 22

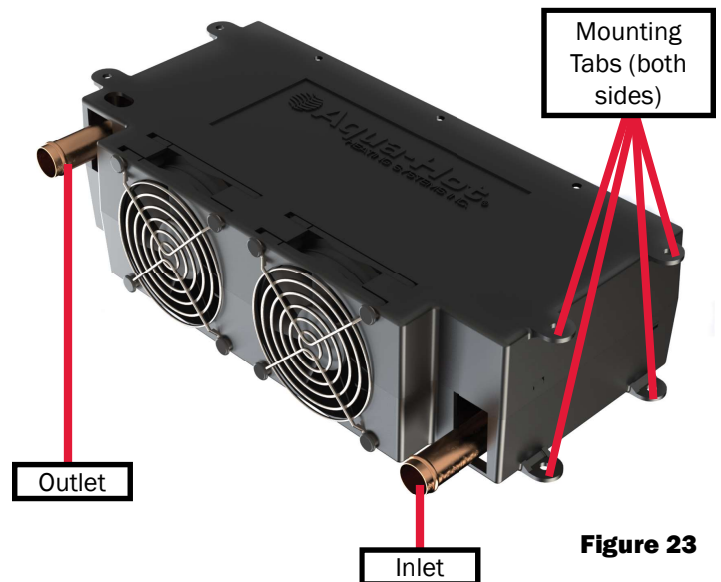

Figure 23

NOTE: The diagram below is simply a reference to show the layout and flow of the plumbing to and from heat exchangers. Placement and quantity may vary depending on the coach.

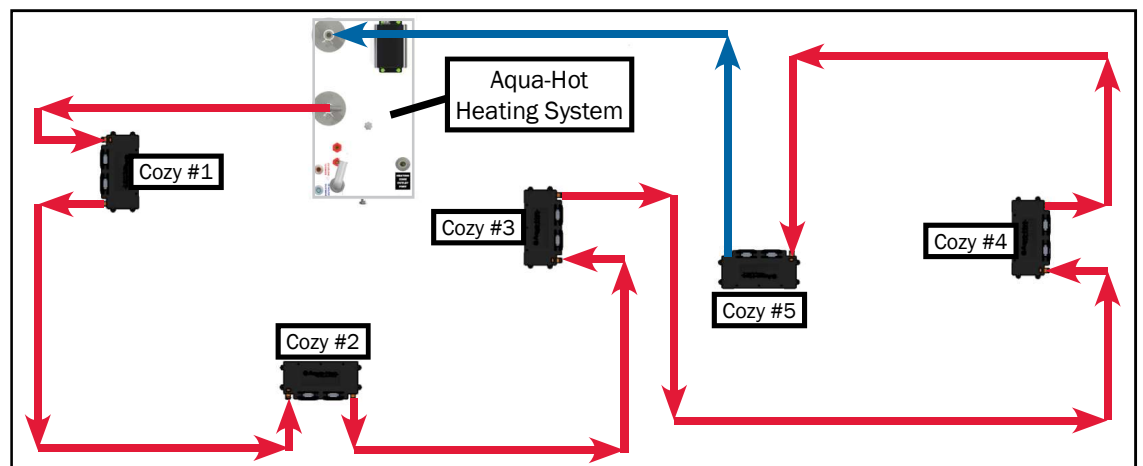

Figure 24



Figure 25

NOTE: The AC relay enclosure has been hidden in these views to allow an unobstructed view of the constant tension clamps.

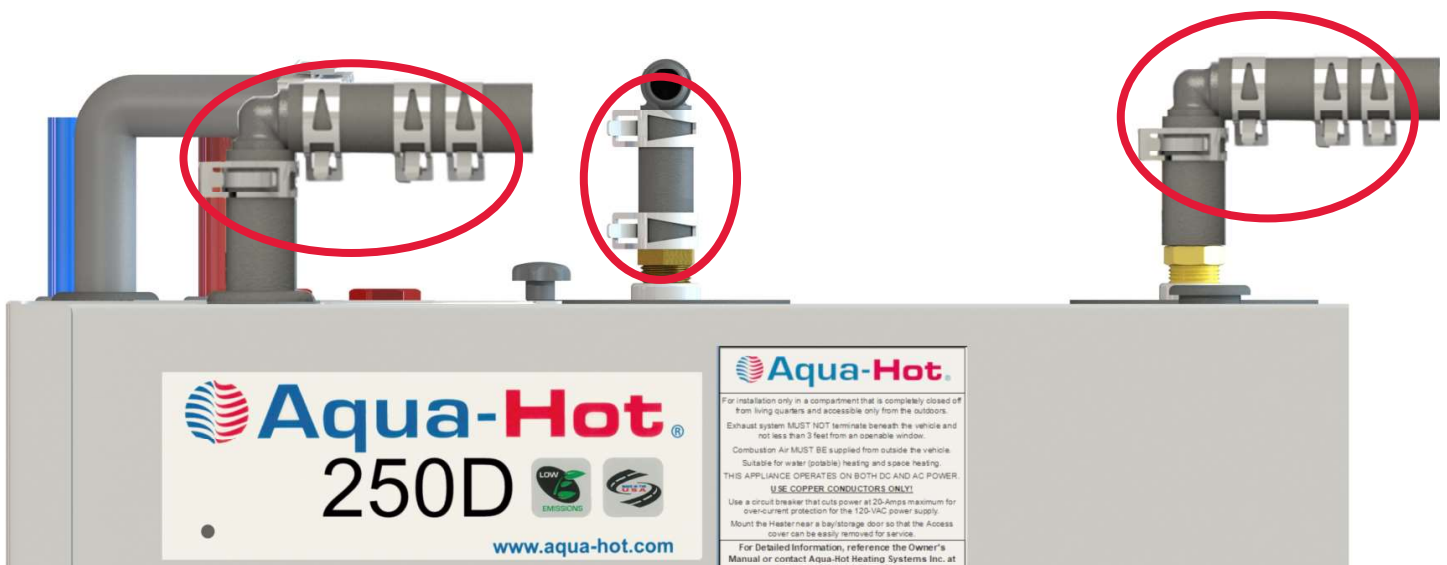

Figure 26

Domestic Water System Requirements

- Reference A119.2/NFPA 501C Standard on Recreational Vehicles 1993 Edition for relevant regulatory information regarding the design of Domestic Water Systems.
- The Aqua-Hot is equipped with a pressure relief valve and a tempering valve in order to provide safe hot water without chance of scalding or an over-pressurized system.
- Plumb the domestic water system according to Figure 27.

NOTE: Extended exposure to household bleach will corrode the components of the Aqua-Hot that will potentially dramatically shorten the operational lifetime of the Aqua-Hot. Under no circumstances is the Aqua-Hot to be exposed to household bleach for extended periods of time. This type of damage is not covered by the Aqua-Hot warranty.

Plumbing the Domestic Water System

The Aqua-Hot is also able to provide domestic hot water while the boiler tank is up at operating temperature. Activate the diesel burner to provide adequate heat for hot water needs. The electric element will only provide light duty hot water.

The tempering valve is integrated into the cabinet of the Aqua-Hot, and is set upon departure from the Aqua-Hot factory. So long as the tempering valve is not modified, it will provide hot, non-scalding water.

Instructions

1. Locate the domestic cold water inlet (blue PEX tube) and connect it to the vehicle's domestic cold water system.
2. Locate the domestic hot water outlet (red PEX tube) and connect it to the vehicle's domestic hot water system.

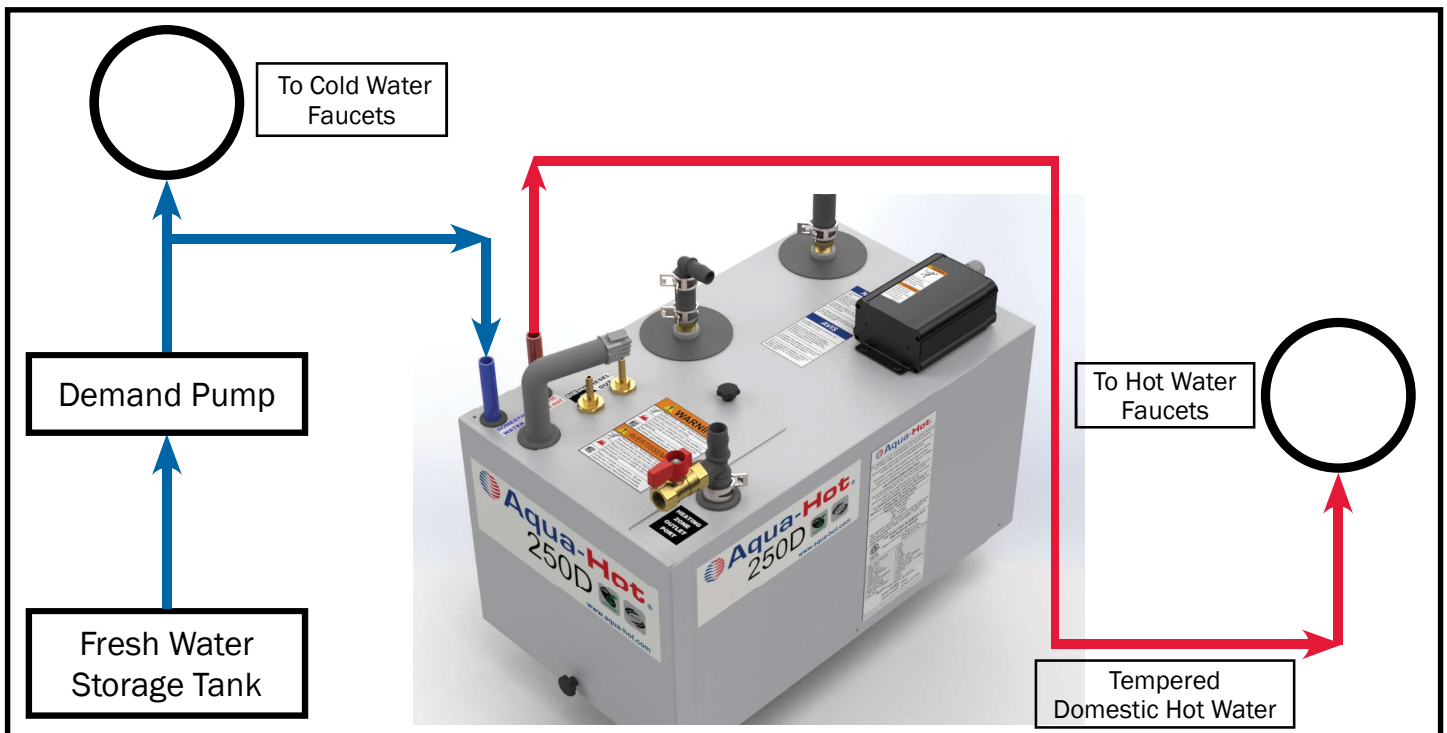

Figure 27

Interior Switch Panel

Select a location in the interior of the coach that allows for easy operator access. The switch panel should be installed in a central location inside the coach that is easily accessible to turn the system on and off. Mounting plate dimensions for the panel are shown below.

Coach Control Panel Screen:

Newer Aqua-Hot units may have a coach touch-screen display instead of the interior switch panel. This section is only for the installation and wiring for the interior switch panel.

All electrical installations, systems, and equipment shall comply with Article 551, Parts I through VI of NFPA 70, as well as the regulation of authorities having jurisdiction and CSA Standard B139.

NOTE: Be sure to attach "Jumper Wires" where necessary. Reference the following switch diagrams.

Switch Panel Mounting

1. Cut out a 3.75" W x 1.25" H opening for the switch panel plate. Reference Figure 28.
2. Once the switch panel has been completely wired, permanently mount the switch panel in place.
3. Using four countersunk 3mm (#4) screws, secure the switch plate into place over the cutout just made.
4. Move both switches to the OFF position by pressing them in a downward motion.

Switch Panel Wiring

1. Run 16-gauge wires from the switch panel to the 8-way connector to the Aqua-Hot.
2. Strip and crimp insulated female terminals onto each wire at the switch panel location.
3. Connect all switch wires to the appropriate switch connections. Reference the following diagram and the schematic on Page 32.
4. Run the wires from the switch to Pins #3 and #4 on the 8-way connector at the Aqua-Hot.

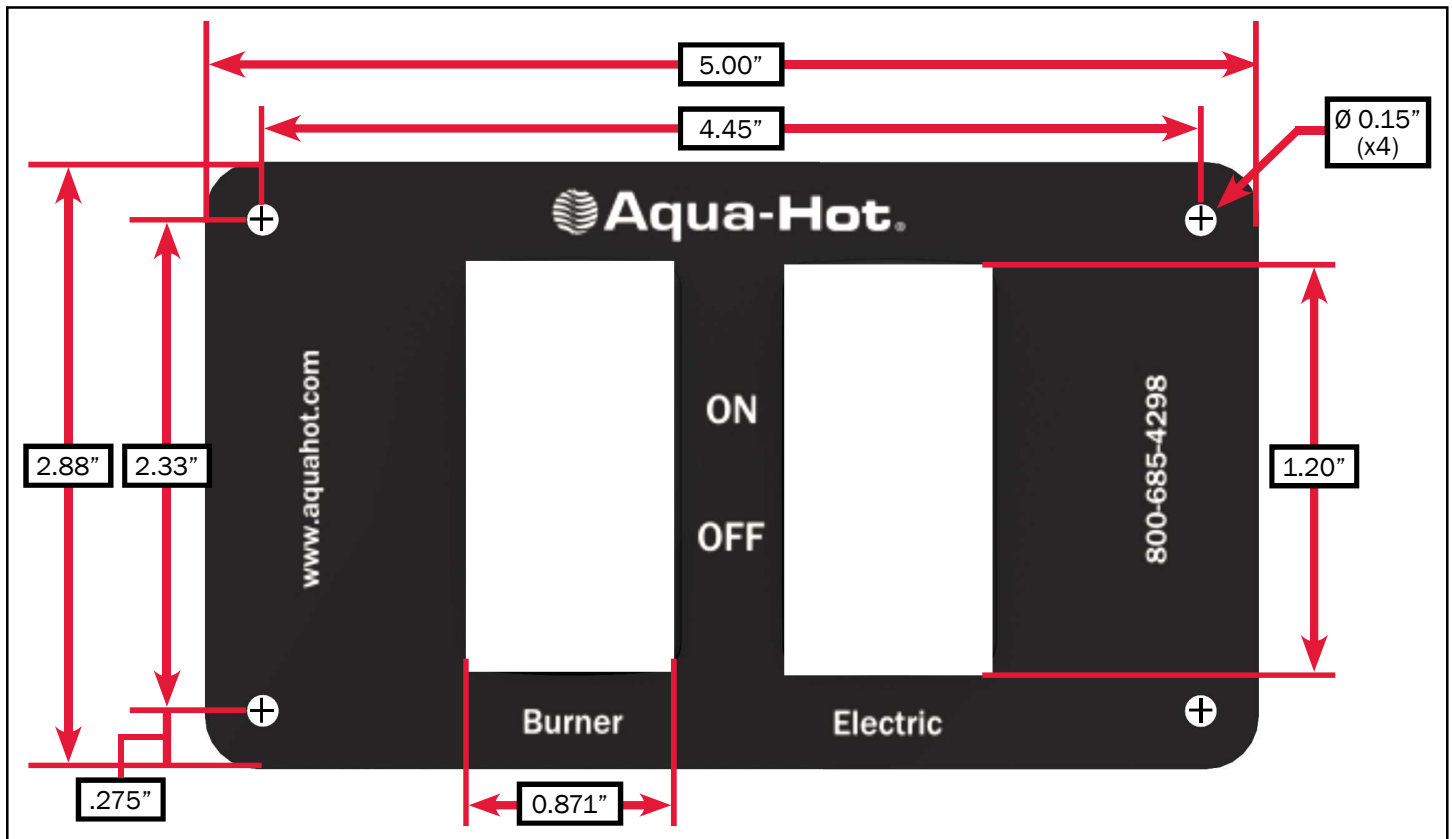
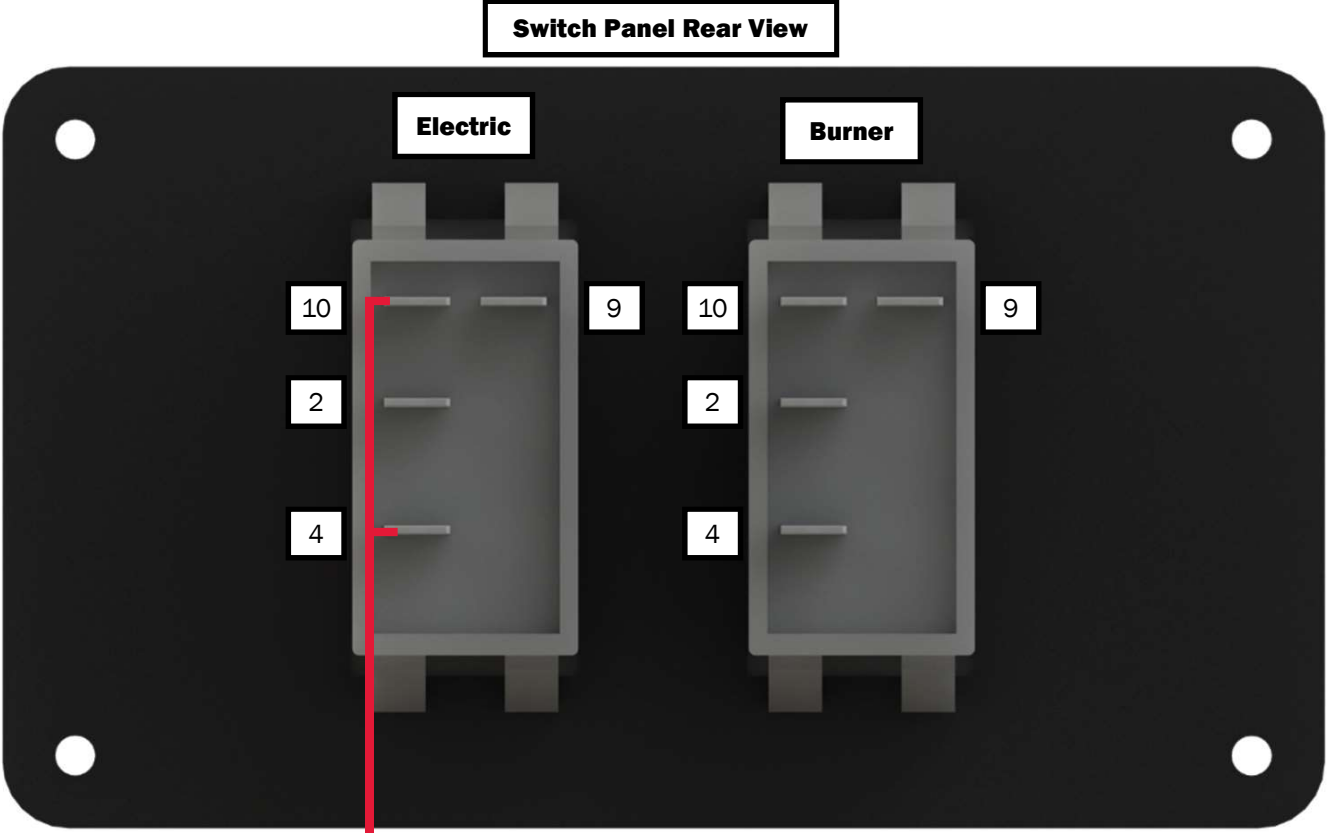

Figure 28



Jumper Pins
(see note)

Figure 29

NOTE: The Electric Element switch must possess a jumper wire between Pin 4 and Pin 10 as depicted.

AC Electric Switch	12-Pin Mate-N-Lock	Burner Switch	12-Pin Mate-N-Lock
#4	#9	#4	#3
#2	#10	#2	#4
#9	Chassis Ground	#9	Chassis Ground
		#10	#11

Wire Insertion View Shown



Figure 30

Receptacle Housing Information		
Manufacturer	Part No.	Description
TE Connectivity	1-480709-0	Mate-N-Lock

Diesel Fuel System

The following section will outline details of installing the diesel fuel delivery system to the Aqua-Hot 250D. These guidelines and instructions are to be followed exactly. Failure to follow instructions herein can cause damage to the Aqua-Hot unit, coach, and may cause serious personal injury.

Fuel Filter

A 10 Micron diesel fuel filter must be installed at the diesel fuel source at all times during the operation of the Aqua-Hot 250D. This fuel filter ensures clean fuel is delivered to the fuel nozzle at all times. Ensure that the fuel filter assembly is mounted in an accessible area, as the fuel filter needs to be replaced regularly to ensure optimal operation of the 250D.

NOTE: If an auxiliary fuel tank is required, be sure to consult the ANSI/NFPA 1192 Handbook concerning heating systems' diesel fuel specifications, and fuel distribution specifications.

NOTE: Ensure that the fuel filter is installed with correct flow in mind as referenced in Figure 32.

Fuel System Requirements

- The diesel fuel supply should be drawn directly from the vehicle's main fuel tank, if applicable.
- The fuel tank should be equipped with a dedicated fuel pick-up pipe (outlet port and inlet port).
- Use ¼" I.D. (Inside Diameter) fuel lines.
- The combined length of the supply and return fuel lines should not exceed 50 feet in total length.
- All fuel lines should be laid as flat as possible, and any extreme rises in height should be avoided to eliminate any potential air traps.
- Run the fuel lines in areas where they cannot be pinched, kinked, or otherwise damaged during normal operation.
- Run the fuel tank outlet fuel line past the fuel filter in preparation for Step 5.
- Secure all fuel lines where necessary, and apply protective shielding in areas where chafing may occur.
- All fuel-fitting hardware (at the vehicle fuel tank, fuel filter, and Aqua-Hot parts) must be ¼" NPT or greater with a barbed fitting. Fuel fittings that are less than ¼" NPT may restrict fuel flow, thereby compromising the diesel burner's performance.
- The maximum allowable suction height is 7 feet. Reference Figure 34.
- The maximum allowable head pressure is 10 feet. Reference Figure 35.

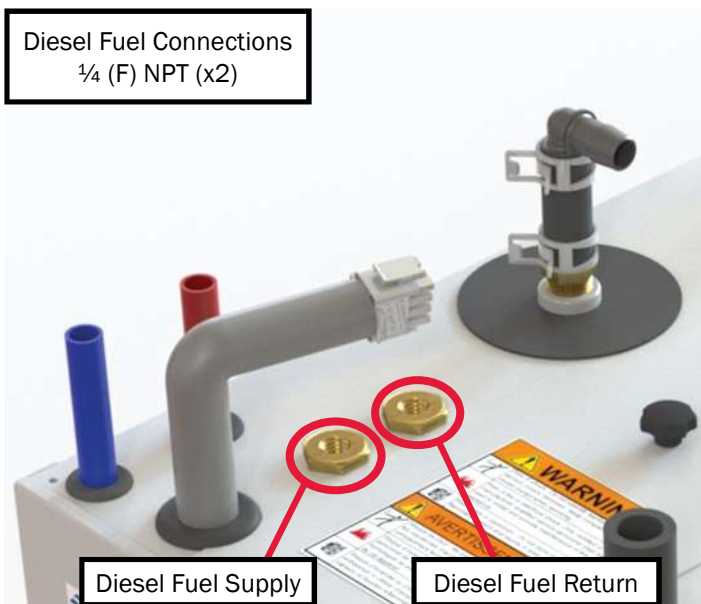

Figure 31

Diesel Fuel System

Fuel System Installation

1. Run two ¼" fuel lines from the fuel tank inlet and outlet ports to the Aqua-Hot. Label both fuel lines indicating whether the line is incoming or outgoing.
2. Install and tighten the fuel fittings onto the two ports of the fuel filter. Reference Figure 32 for the correct connection configuration.
3. Install and tighten the appropriate fuel fittings onto the Aqua-Hot's fuel ports.
4. Connect the Aqua-Hot's fuel lines to the fuel tank.
5. Cut the fuel line at the fuel filter mounting location and connect the fuel lines as illustrated in Figure 32.

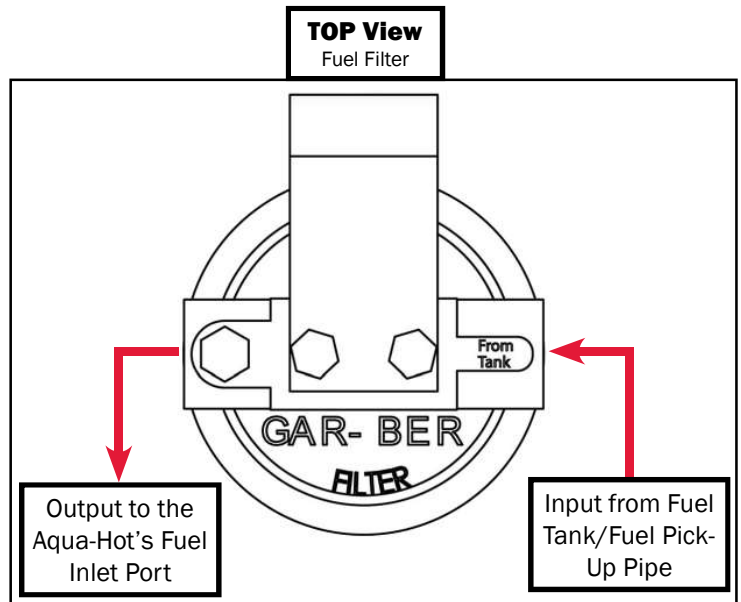

Figure 32

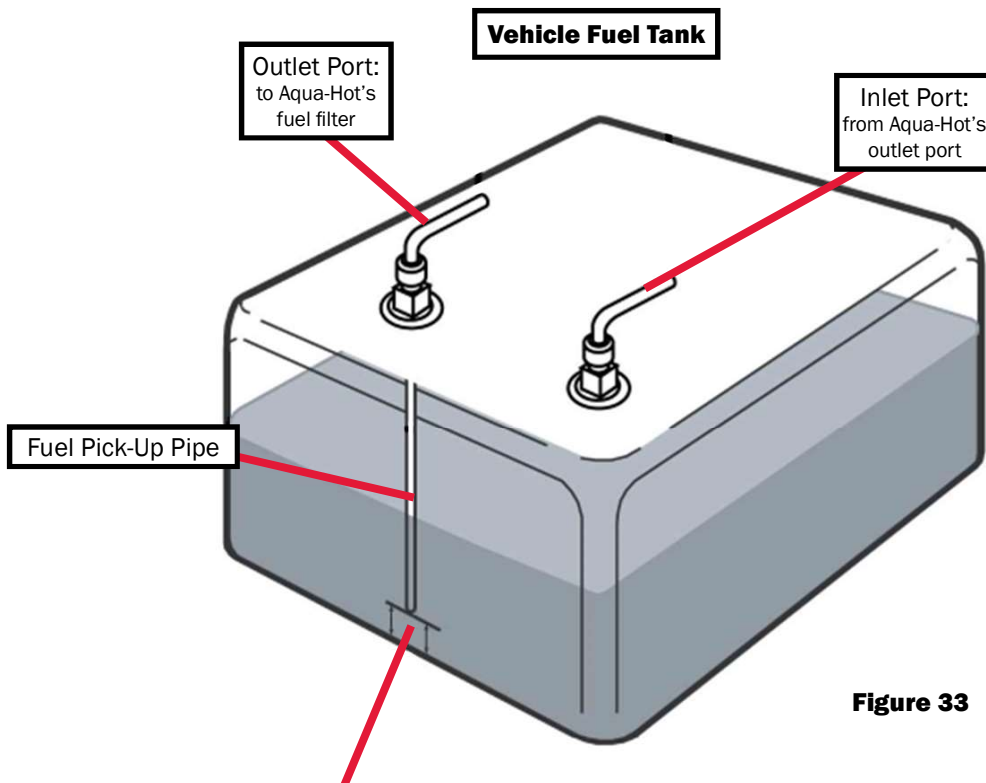

Figure 33

NOTE: The fuel pick-up pipe should not extend further than the motor home's engine fuel supply pick-up and should be consistent with the on-board generator's fuel supply pick-up length.

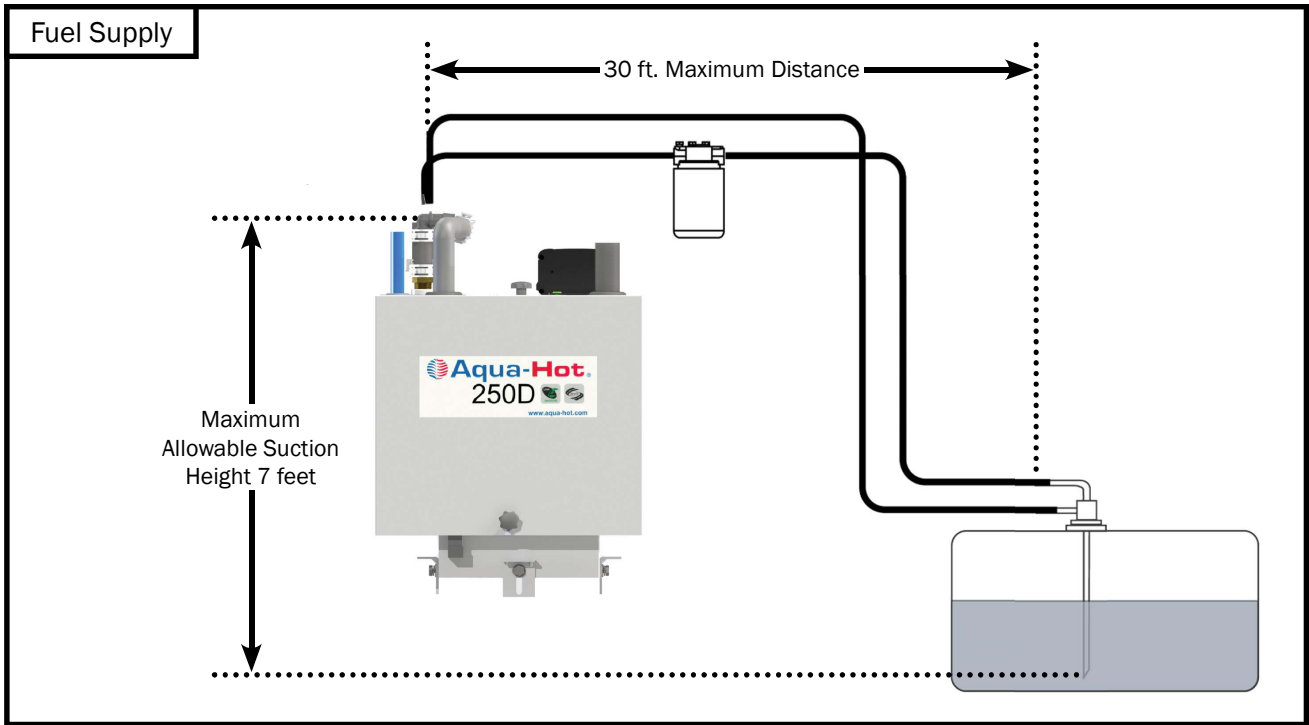

Figure 34

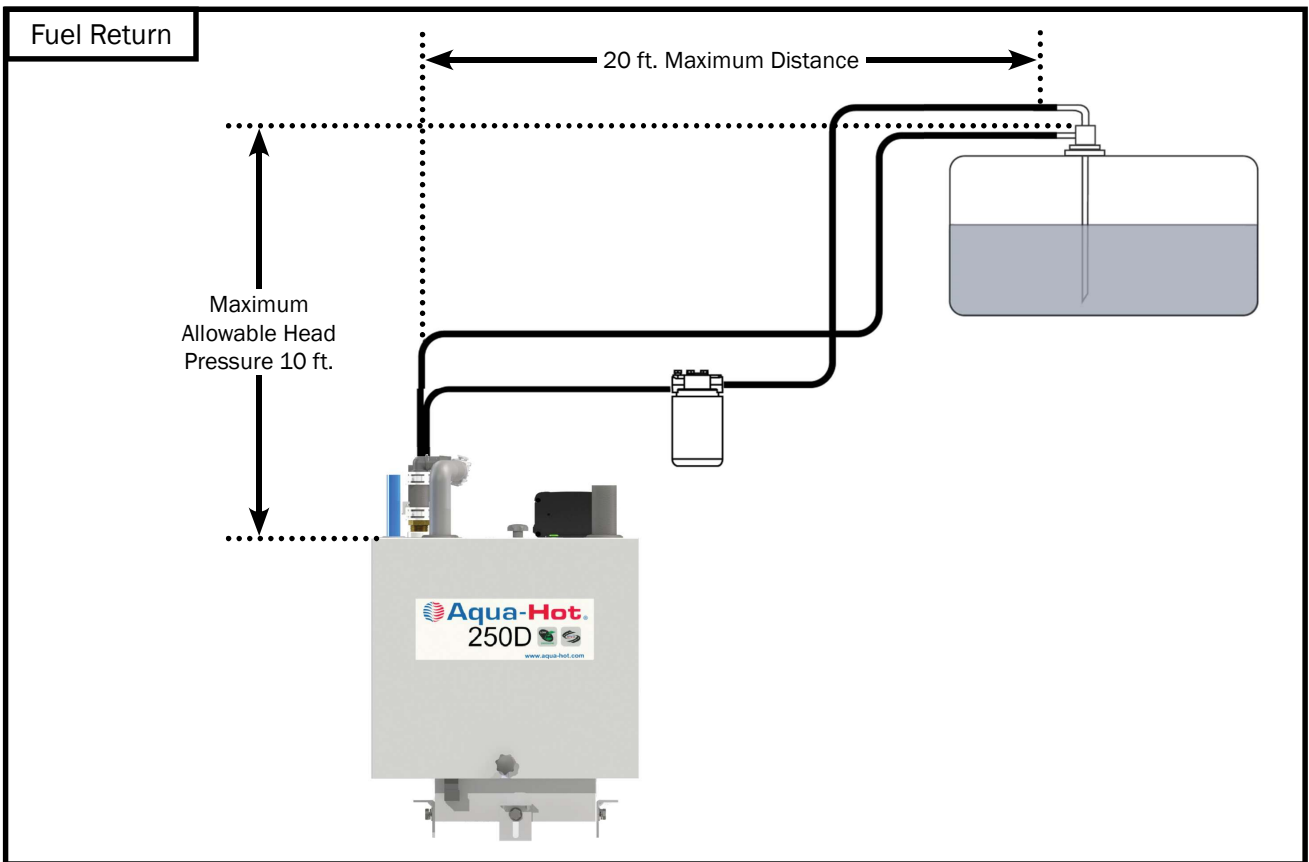

Figure 35

Exhaust System

This section outlines in detail the specifications and requirements for installing the exhaust system. These requirements must be adhered to in order to create optimal operating conditions for the Aqua-Hot unit.



 <h1 style="margin: 0;">WARNING</h1>
<p>Exhaust from the Aqua-Hot is very HOT and must be kept away from any heat sensitive materials.</p> <p>Failure to do so may result in a fire.</p>

Exhaust System Requirements

- Do NOT direct exhaust downward as fire may result when parked in dry, grassy areas.
- Exhaust must not terminate beneath the vehicle, or beneath an openable window or vent.
- Do NOT terminate the exhaust pipe within the awning area of the coach, if applicable.
- Ensure that the exhaust is shunted away from slide-out areas.
- Angle the exhaust pipe away from, and towards the back of the vehicle so that the exhaust naturally moves away while the vehicle is in motion.
- Use standard 2" automotive exhaust pipe and avoid any bends, if possible.
- Do NOT use galvanized pipe or fittings, only black-iron pipe fittings are permitted for use.

 <h1 style="margin: 0;">CAUTION</h1>
<p>All Aqua-Hot exhaust system installations MUST utilize the two black pipe nipples and the black pipe elbow, which are supplied separately from the heating system in the configuration best suited for the particular recreational vehicle application. Failure to conform to this standard could create a hazardous situation and will void the Aqua-Hot's ETL product listing.</p>

Refer to "Internal Combustion Engine Exhaust and Vehicle Wall Openings" in RVIA's ANSI/NFPA 1192 Handbook for Recreational Vehicle Standards, as well as the National Fire Protection Association's (NFPA) 1192 Standard on Recreational Vehicles for additional information.

 <p>LDE-200-815</p>	 <h2 style="margin: 0;">CAUTION</h2> <p>Risk of Fire or Equipment Damage</p> <p>Hot exhaust tube can ignite flammable materials.</p> <p>Maintain 2-inch/50.8mm clearances from any heat sensitive material, including fuel lines, wiring and hoses.</p>
---	---

Should the particular application require modification of the exhaust pipe, please contact the Aqua-Hot Heating Systems Product Application Department at 574-AIR-XCEL (574-247-9235).

Installing the Exhaust System

Aqua-Hot separately supplies a kit that contains two 1.5" NPT black pipe nipples - one is 3" in length, the other is 4" in length. These three exhaust system components must be utilized with all Aqua-Hot product installations. Be sure to reference Figures 38 & 39 to determine which exhaust nipple should be connected directly to the Aqua-Hot's exhaust port (i.e. the 3" or 4" black pipe nipple).

1. Run the exhaust pipe to the driver's side or the back of the vehicle to ensure that the exhaust fumes cannot enter into the passenger compartment. Be sure to keep the exhaust away from the slide-out areas.
2. Be sure to secure the end of the exhaust pipe to the vehicle with the proper exhaust hanger/support hardware.

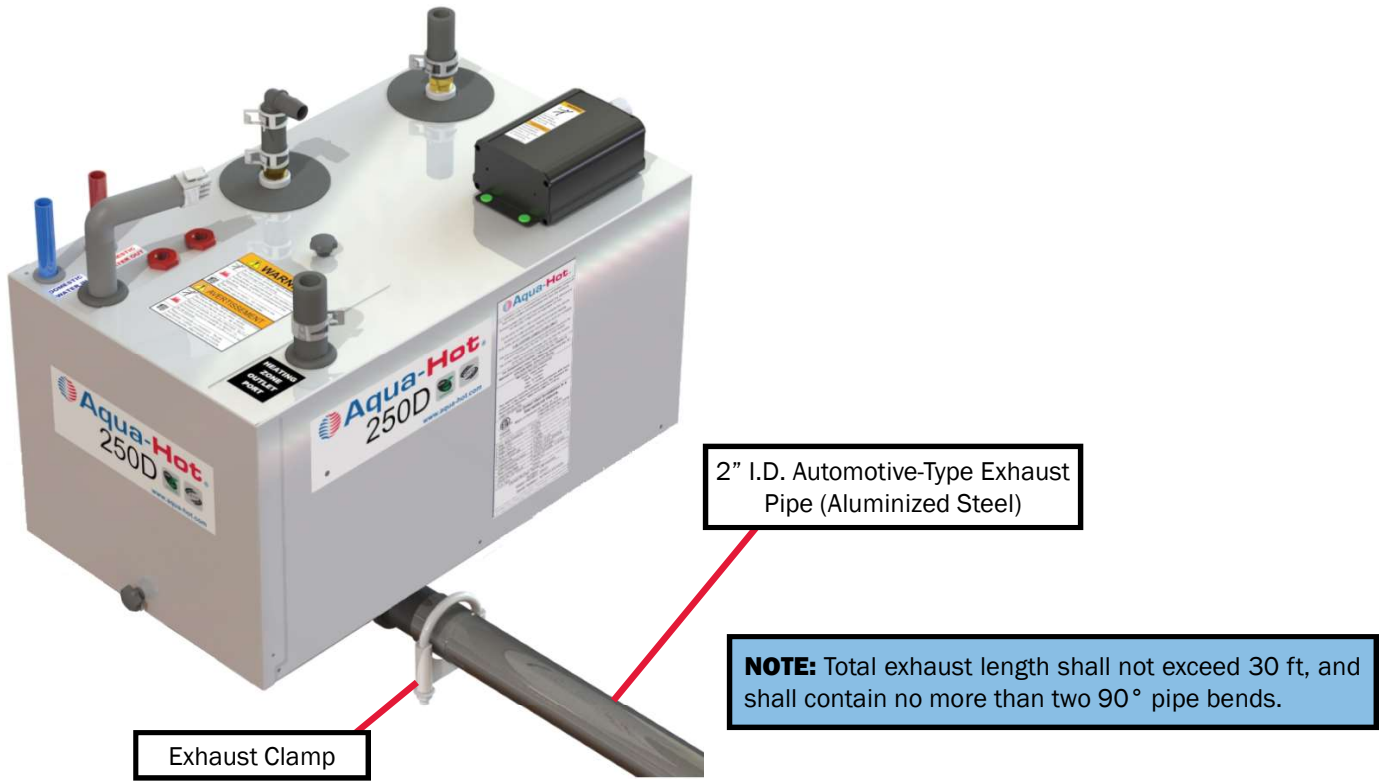



Figure 36



Figure 37



CAUTION

Risk of Fire or Equipment Damage
Hot exhaust tube can ignite flammable materials.

Maintain 2-inch/50.8mm clearances from any heat sensitive material, including fuel lines, wiring and hoses.

LDE-200-815



WARNING

Heater Exhaust Produces Carbon Monoxide (CO2)
Carbon Monoxide (CO2) can cause headaches, brain damage or death.

DO NOT operate heater within a closed interior area. Confirm heater switch is in OFF position when vehicle is in an enclosed space.

LDE-200-805

NOTE: If the exhaust pipe has low points, a 1/8" weep hole is required so as to drain any condensation from the exhaust pipe.

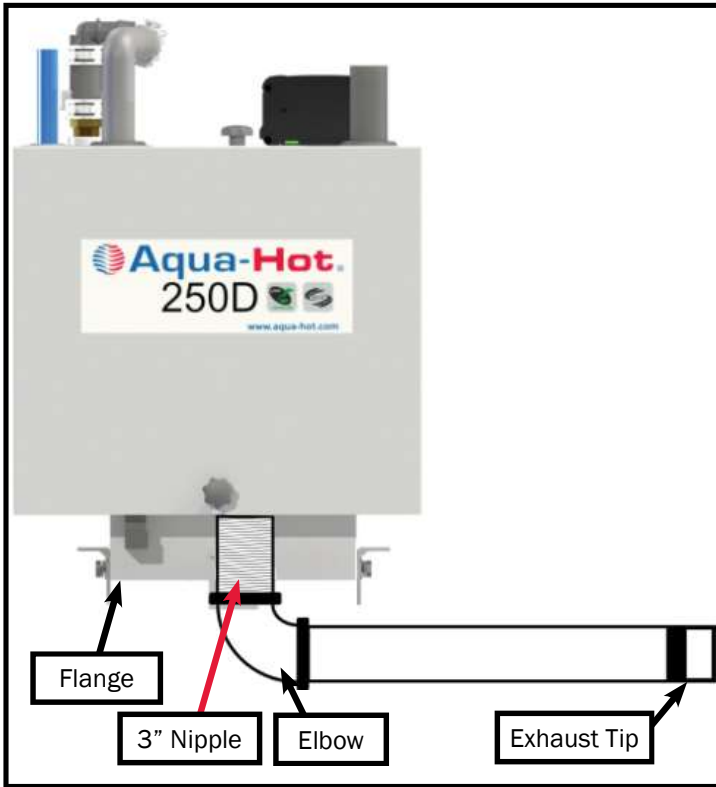

Figure 38

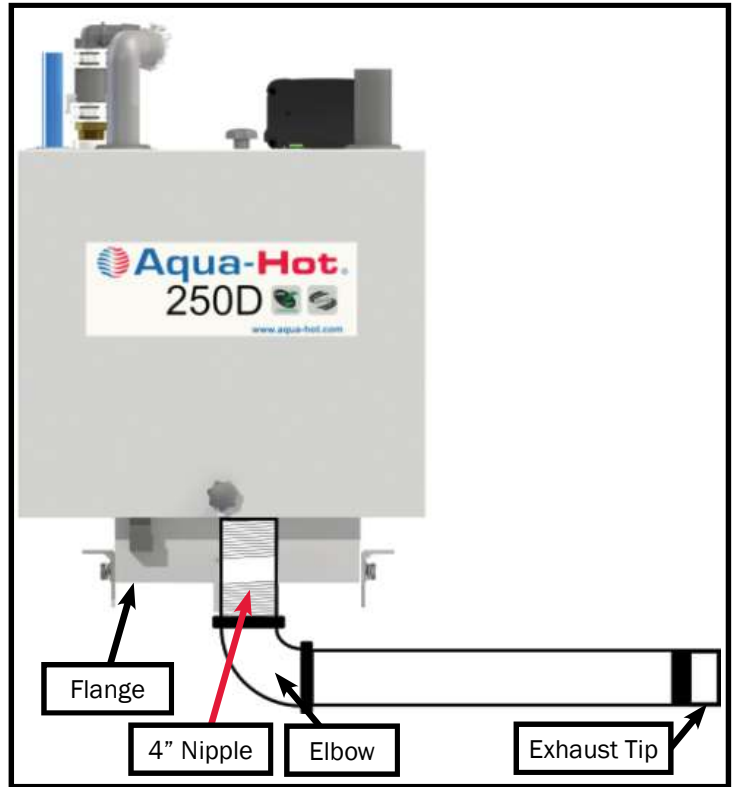

Figure 39

NOTE: Exhaust must terminate at least 3 ft from any coach openings (doors and windows).

200 Series Pin-Out Information

The following section serves to provide electrical information particularly pertaining to pin-out configurations to assist in correctly wiring the coach-side electrical connections.

WARNING

Installation must be performed by a professional installer or technician as per national/local regulations.

Improper installation can cause property damage, injury, or death.

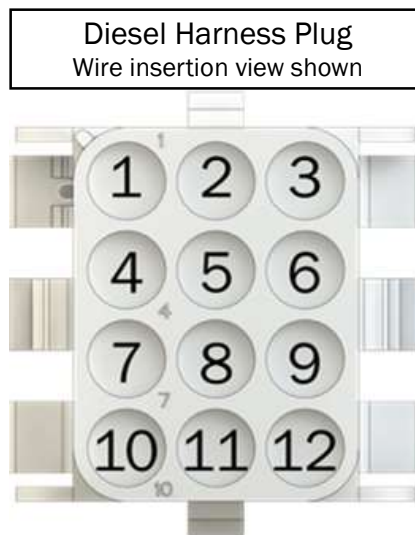

Figure 40

Pin Number	Coach Side
1	12V DC (25A-Fused) from Coach
2	Coach Ground
3	Return Signal from Burner Switch
4	Output to Burner Switch
5	Output to Room Thermostat
6	Return from Room Thermostat
7	Output to Heat Exchangers
8	Return from Heat Exchangers
9	Electric Switch Return Signal
10	Electric Switch Power
11	Burner Indicator Light
12	Optional Boost Pump

Connecting the 250D to 12V DC Power



CAUTION

DO NOT connect 12V DC power to the Aqua-Hot if the vehicle requires welding. Electrical welding will cause serious, irreversible damage to the Aqua-Hot.

Before connecting power to the Aqua-Hot, it is imperative that the proper wire gauge be determined and utilized. Reference ANSI/RVIA-LV for proper wire gauge sizing. Please note that under full-load conditions, the Aqua-Hot can draw as much as 10 amperes of DC current.

Be sure to protect against accidental shorting (ie, chassis shorting) by incorporating a 25A rated in-line fuse into the power wire at the battery location. The table below calls out the proper connector and terminals needed to interface with the Aqua-Hot.

NOTE: For wiring the cozy heat exchangers, see Page 14.



Supplying Power to the 12-Pin Mate-N-Lock

1. Run two properly gauged wires (red for + and black for -) from the main power disconnect to the 12-Pin Mate-N-Lock connector located at the top of the Aqua-Hot.
 - The red (+) wire must be fused with a 25A fuse to protect the Aqua-Hot from an over-current condition.
2. Crimp the appropriate terminals called out in Table 1 to the wires. Perform a pull test to ensure that the wires do not come out of the terminals.
3. Insert the power wire (+) into Pin #1 of the 12-Pin Mate-N-Lock receptacle housing.
4. Insert the ground wire (-) to Pin #2 of the 12-Pin Mate-N-Lock receptacle housing.

Wiring the Coach Thermostat

1. Run two properly gauged wires (red + and black -) from the coach thermostat to the appropriate terminals as annotated on Page 19.
2. Crimp the appropriate terminals called out in Table 1 to the correct wires.
3. Perform a pull test to ensure that the wires do not become removed from the terminals.
4. Insert the positive signal wire into Pin #6 of the 12-Pin receptacle housing.
5. Insert the thermostat ground signal wire into Pin #8 of the 12-Pin receptacle housing.

Table 1: 12-Pin Mate-N-Lock Connector and Terminals

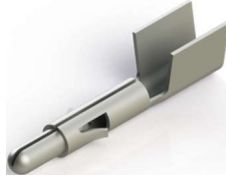
Connector/Terminal	Manufacturer Part Number	Part Image
TE Connectivity Universal "MATE-N-LOCK"	1-480709-0	
TE Connectivity 20-14 AWG UMNL	350547	
TE Connectivity 10-12 AWG UMNL	640309-3	

Connecting the Aqua-Hot to AC Power

WARNING

Do NOT activate the burner until antifreeze and water heating solution has been added to the boiler tank and the heating system has been completely bled of air. Operating the Aqua-Hot without the antifreeze and water heating solution could cause serious damage to the Aqua-Hot boiler tank.

The following section explains in detail how to wire and connect the Aqua-Hot into your coach-side 120V AC power system. Included are examples of plugs and connections, as well as mating part numbers and location call-outs.

The Aqua-Hot utilizes Molex 19403 and 19045 series connectors for the AC electrical circuit. These are self-contained connectors which can be readily purchased from your choice of electronics supplier. Listed below are three different mating connections.

- Installation must be performed by a qualified professional according to current national regulations. Reference A119.2/NFPA 501C Standard on Recreational Vehicles 1993 Edition.
- The boiler must be connected to a 120V AC supply permanently and be protected with a 20A breaker (minimum). The 120V AC must be separate from 12V DC.
- It must be possible to disconnect the power to the boiler, either an easily accessible plug or a circuit breaker.
- Refer to the schematic on Page 32.

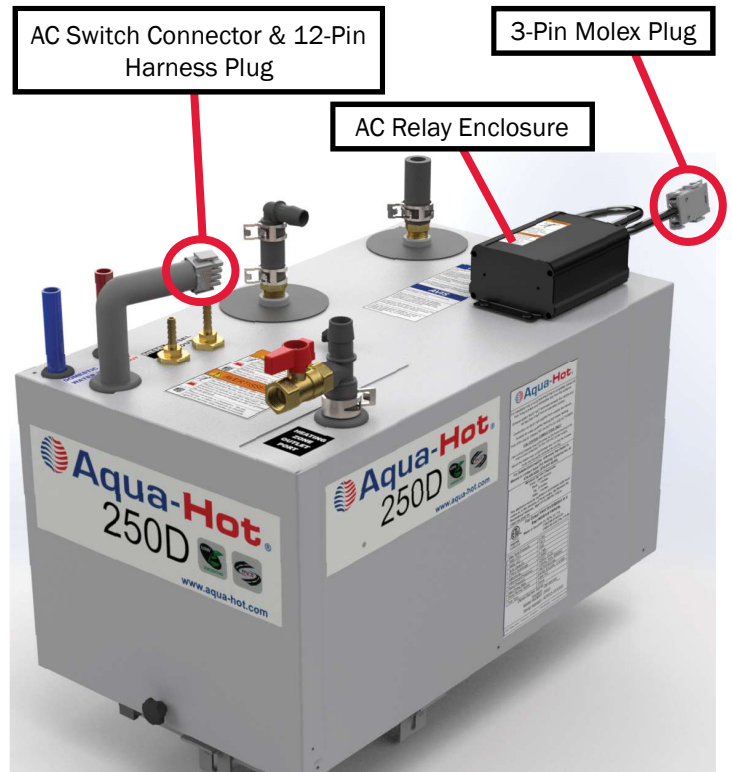

Figure 41

1. Route three 120V AC power source wires to the Aqua-Hot heater.
2. Using one of the Molex connectors described below, crimp the 120V AC power source wire into the connector.
3. Plug the new crimped 120V AC Molex connection into the mating Molex connection on the Aqua-Hot.

Self-Contained Power Connector - 2 Circuit for Solid Wire		
Size	Part Number	Housing Color
12AWG-14AWG	19045-1000	White
Self-Contained Power Connector - 2 Circuit for Stranded Wire		
14AWG-16AWG	19403-1011	Blue
12AWG	19403-1010	Yellow

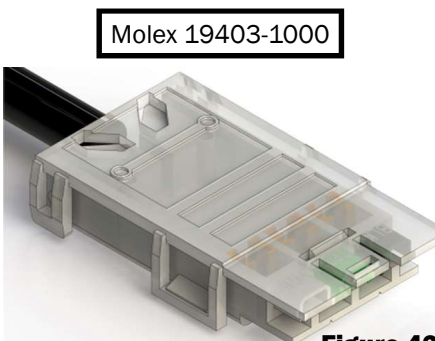

Figure 42

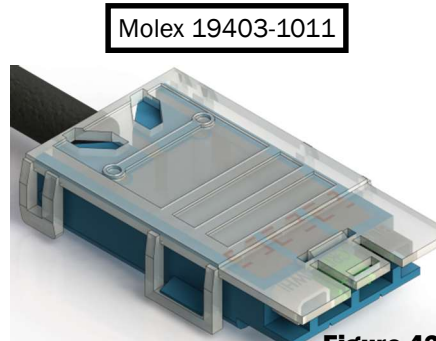

Figure 43

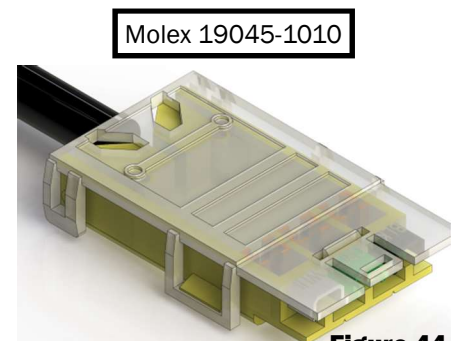

Figure 44

Filling and Purging the Aqua-Hot 250D

Before the first activation of the Aqua-Hot, fill the unit with antifreeze and water heating solution. Without the solution present, the Aqua-Hot will not operate. Follow the directions below to fill and purge the Aqua-Hot.

A 50/50 mixture of “GRAS” (Generally Recognized as Safe) approved **propylene glycol** antifreeze and distilled or de-ionized water is recommended. The mixture may be modified to provide the most adequate freezing, boiling, and rust/anti-corrosive protection. Reference pages 34-35 for more information about antifreeze.

Procedure:

1. Locate the fill valve at the zone port outlet (Figure 46).
2. Make a ½” NPT connection from the propylene glycol source to the fill valve.
3. Remove the access cover and locate the 3-way valve in the Aqua-Hot. Ensure that the sight glass is oriented as shown below. Reference Page 5, Figure 2 (Item #3) for the 3-Way Valve location.

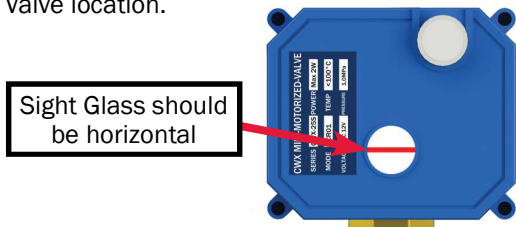

Figure 45

NOTE: If the sight glass is not oriented in this way while the unit is cold, apply power to the main harness connection and the valve will return to horizontal.

4. Activate the fluid transfer pump and begin filling the Aqua-Hot through the fill valve.
5. When the fluid level reaches the cold mark on the expansion bottle, deactivate the fluid pump.
6. Close the fill valve and disconnect the pump.
7. Reattach the access cover.
8. Turn on the burner at the interior control panel and set the thermostat to its maximum temperature to allow for interior heating. Let the Aqua-Hot run for at least 20 minutes to ensure that any air in the heating loop has been purged. If necessary, top off the propylene glycol solution at the fluid expansion bottle.

WARNING

Only Propylene Glycol based “boiler” antifreeze deemed “GRAS” by the FDA shall be used in the Aqua-Hot’s hydronic heating system, Failure to use approved antifreeze could cause serious injury or death.

CAUTION

Ensure that the expansion tube is connected to both the expansion bottle and to the Aqua-Hot. Also ensure that the overflow hose is connected to the top port on the expansion bottle and is allowed to flow out of the coach through the floor of the bay as shown below.

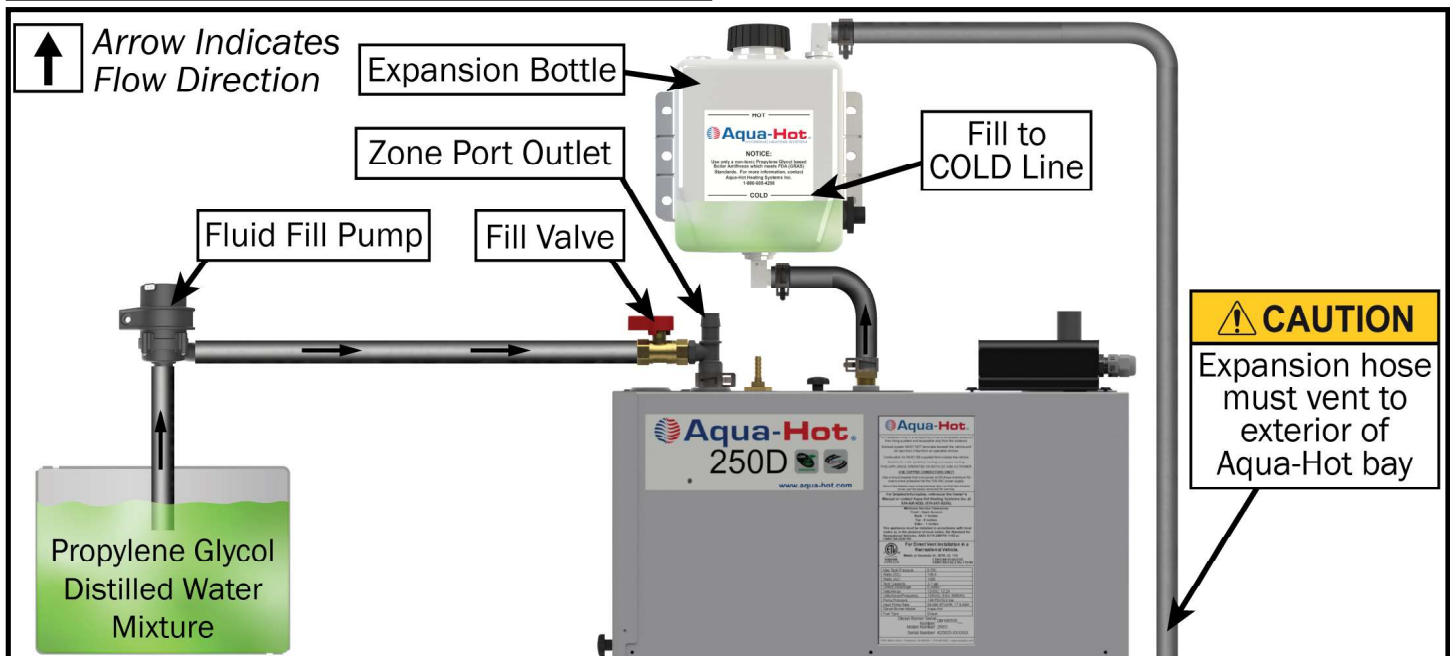

Figure 46

Aqua-Hot First Operation

The first start-up of the Aqua-Hot may not light up perfectly. This is normal. On the diesel systems, fuel lines may not have been bled of air prior to the first start-up. In this case, this non-combustible air must be purged from the system before the burner will light. The burner will attempt to light three times before entering a purge cycle. If that occurs, the Aqua-Hot must be power cycled to reattempt a start-up. Please bear in mind that the first light may be noisy. However, the second light should be quiet and stable.

The main access cover must be installed prior to operation. The access cover depresses a safety switch that will prevent unit operation if the cover is removed or improperly installed.

Activation Instructions (Electric Element):

1. Make sure power supply to the Aqua-Hot is on.
2. Confirm that the antifreeze and distilled water heating solution is adequately filled.
3. Confirm the system and heating loop has been properly purged of any air.
4. Make sure to flush the domestic water system thoroughly with clean water prior to use.
5. Move the electric element switch to the ON position to the supply the 120V AC Electric Element with power.
6. Allow approximately 20 minutes for the electric element to heat the tank. Turn on a hot water faucet, and allow to run until hot water flows. Once there is hot water, close the faucet. This will verify that the electric element is operating as it should.

Once these checks have been confirmed, the electric heating element is now ready for normal operation and use.

Continue to the next procedure to activate the burner.

Activation Instructions (Burner)



1. Make sure there are no blockages or debris to the exhaust outlet or combustion air inlet.
2. Make sure the plumbing lines and fuel lines are properly purged and free of air.
3. Make sure there is adequate diesel fuel in the fuel tank (at least ¼).
4. Move the burner switch to the ON position to activate the diesel burner. Allow the burner to run until it shuts itself off.
5. Once the burner turns on, the circulation pump and combustion air fan should run (can be determined by listening).
6. The burner should start up after approximately 120 seconds. This can be determined by the hot exhaust exiting from the exhaust tube.
7. Allow the burner to run a full cycle. Turn on the heat or hot water inside the RV to confirm the burner is properly operating.

Once the heater has been brought to temperature by the electric element and/or the 12V DC burner, activate interior heat by adjusting the room thermostat up until the heat exchangers activate. The interior heating will not function if there is a demand for hot water, or if the tank is below operating temperature. Therefore, shut off all hot water faucets and allow the burner to heat until it shuts itself off before activating interior heat.

Once these checks have been confirmed, the diesel burner is now ready for normal operation and use.

NOTE: It is recommended to run the burner for at least 20 minutes every month to ensure optimum heater condition.

NOTE: Both the electric heating element and the 12V DC burner are thermostatically controlled. The element and/or burner will automatically maintain the temperature of the boiler tank's antifreeze and water heating solution.

	 WARNING
	Burn Hazard Hot Coolant Circuit with Hot Surfaces can cause severe burns. DO NOT touch or service until equipment has cooled.
LDE-200-810	

Winterizing the Aqua-Hot

The Aqua-Hot's domestic water heating system must be completely drained of domestic water at any time the heater is stored where freezing temperatures may be experienced.

Please follow these instructions when winterizing the Aqua-Hot domestic water heating system. Reference Figure 47 for a system overview.

NOTE: The Aqua-Hot can continue to be used for interior heat once the domestic hot water system has been winterized.

1. Disconnect or shut off any external sources of freshwater.
2. Open all faucets, shower heads, and similar. Open both the "HOT" and "COLD" valves on the faucet, if applicable.
 - If only one valve, open it to the "halfway point".
3. Ensure that the coach is connected to a waste collection point, such as a grey water tank.
4. Attach an external fluid pump to your fresh water connection.
5. Ensure that the fill pump intake hose is situated in a large enough supply of "GRAS" winterization antifreeze so that the pump does not run dry if left unattended.
6. Activate the external fill pump. Allow the pump to run until ONLY antifreeze is exiting the faucets in the coach.
7. Once this has been completed, deactivate and disconnect the external fluid pump.
8. Close all but one faucet in the coach. This will allow the winterization antifreeze to expand and contract as necessary with temperature changes, thereby greatly reducing the likelihood of pressure-related damage to interior pipes.

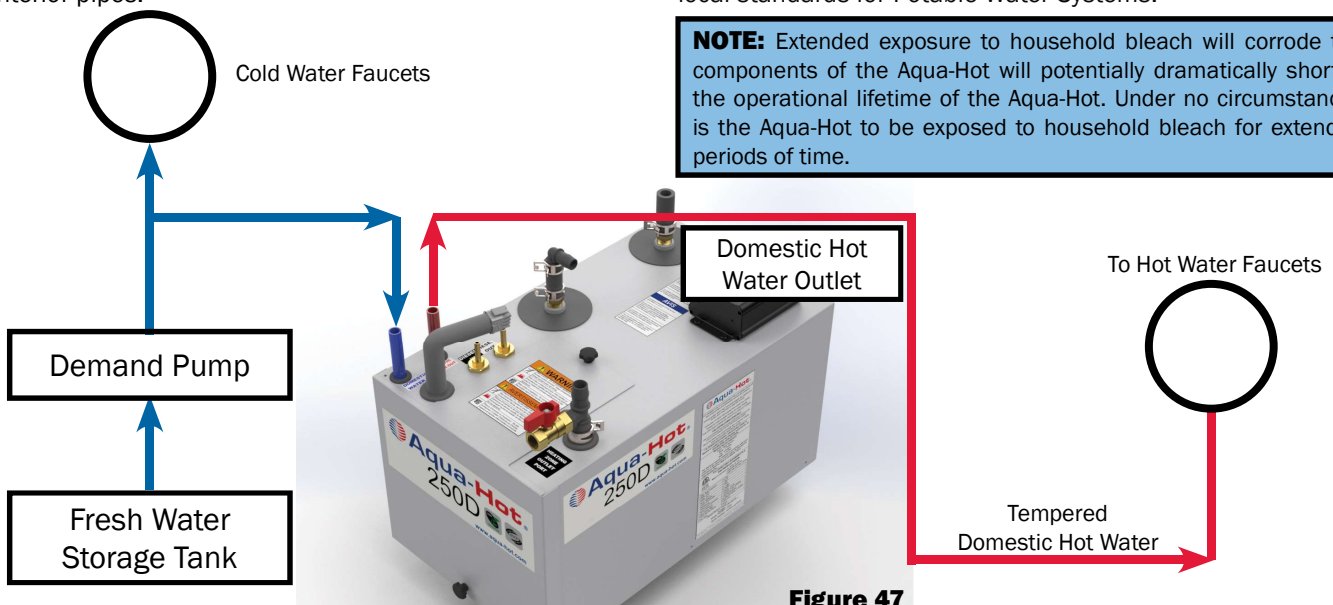

Figure 47

WARNING

Not winterizing the Aqua-Hot when freezing temperatures are present will result in serious damage to the Aqua-Hot domestic water heating system. Ensure that only non-toxic RV antifreeze (FDA approved "GRAS" antifreeze) rated for winterization is used when winterizing this unit. The warranty does not cover freeze damage.

De-Winterization:

1. To de-winterize the unit, connect a freshwater source to the coach.
2. Ensure that all the interior faucets have been re-opened.
3. Turn on the external water source, and allow it to run until winterization antifreeze no longer flows from any faucets.

Disinfecting the Domestic Water System

NOTICE

The Aqua-Hot Heating components are not compatible to prolonged exposure to sodium hypochlorite (bleach or liquid bleach). Using products containing bleach, including water refreshers, may cause corrosion of the domestic water lines, resulting in a catastrophic failure of the Aqua-Hot system by creating leaks that cannot be repaired. This damage is not covered by the Aqua-Hot warranty.

If disinfecting the hot water system, be sure to follow NFPA 1192 Standard of Recreational Vehicles "Instructions for Disinfection of Potable Water Systems" or any other applicable local standards for Potable Water Systems.

NOTE: Extended exposure to household bleach will corrode the components of the Aqua-Hot will potentially dramatically shorten the operational lifetime of the Aqua-Hot. Under no circumstances is the Aqua-Hot to be exposed to household bleach for extended periods of time.

System Schematic

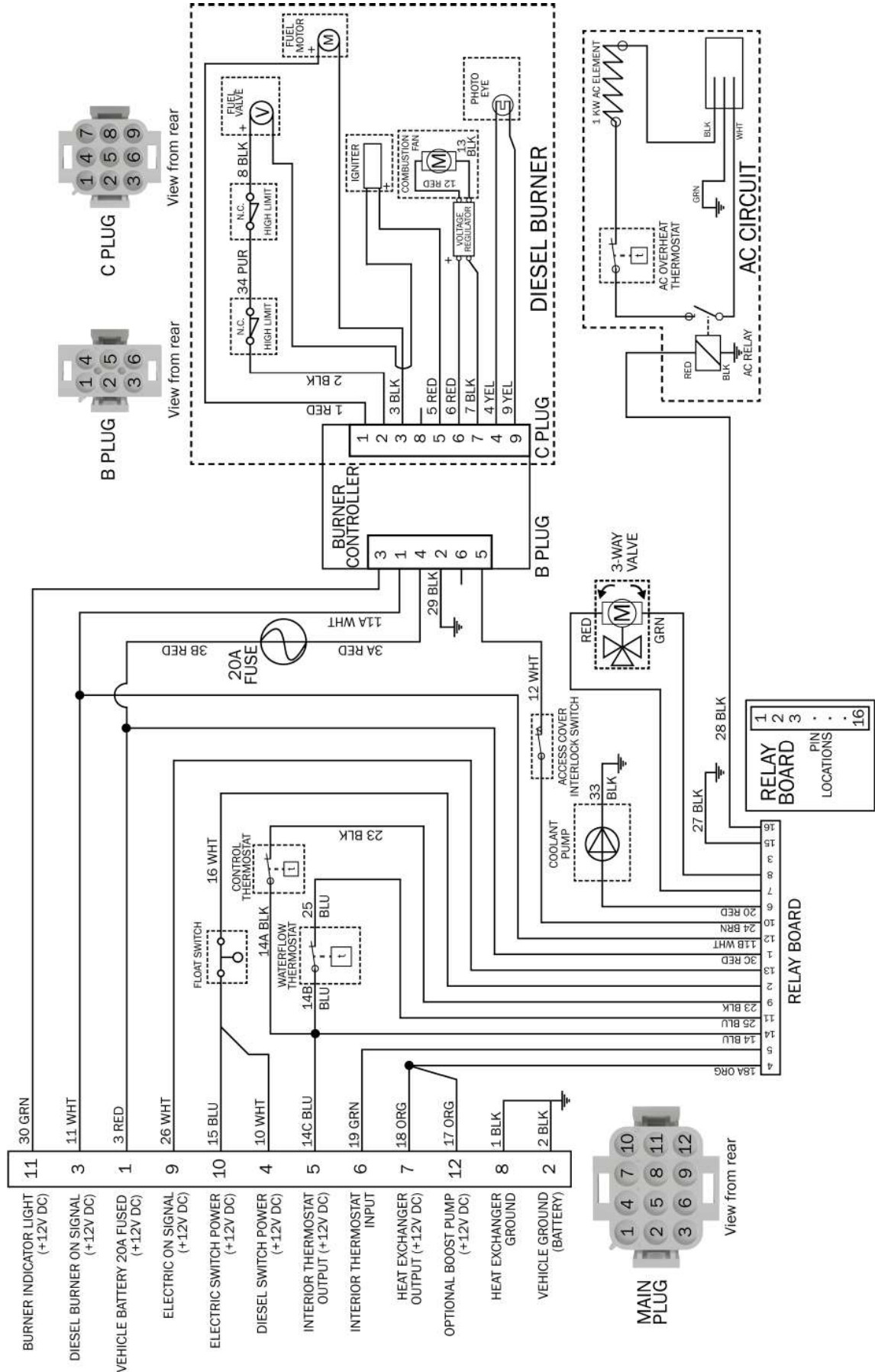

Measuring Antifreeze Using a Refractometer

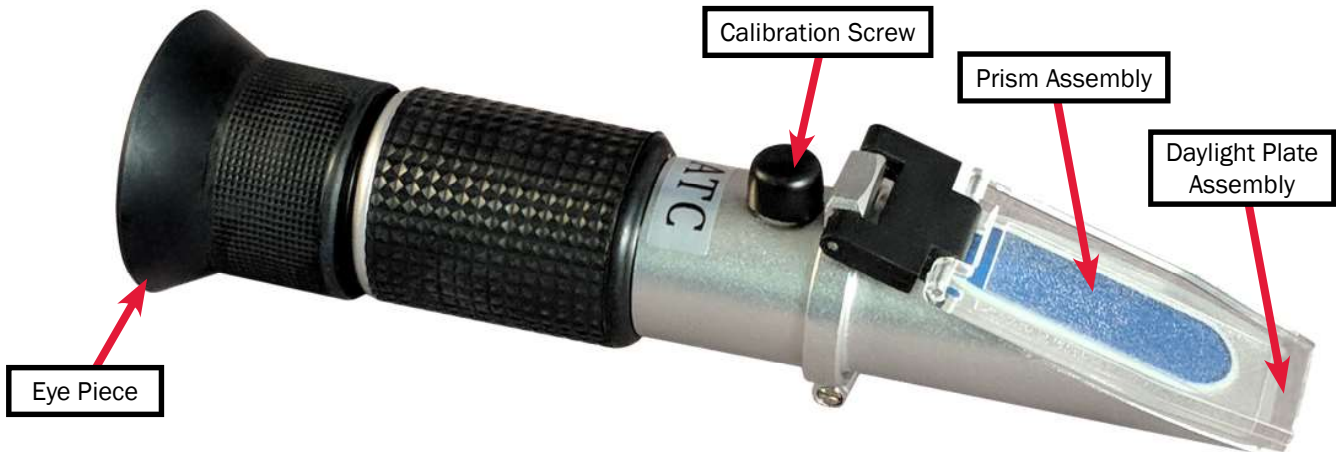

Properly Apply Antifreeze to the Prism Assembly

Use the guide below to properly apply the propylene glycol mixture to the prism assembly of the refractometer. Once that is complete, peer through the eyeglass of the refractometer to continue to the next step.

Adjust the Boundary Line

Once the glycol solution has been properly applied, adjust the calibration screw until the boundary line labeled "Propylene Glycol" is set to 32 °F. The graphic to the right has been designed as an aid, but note that it may differ from what is shown in the refractometer sight glass.

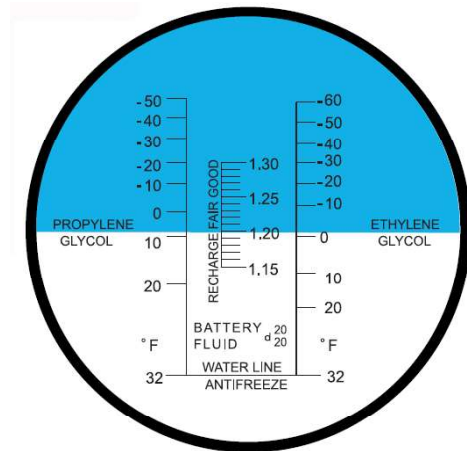

Refractometer Sight Glass

Application of Propylene Glycol

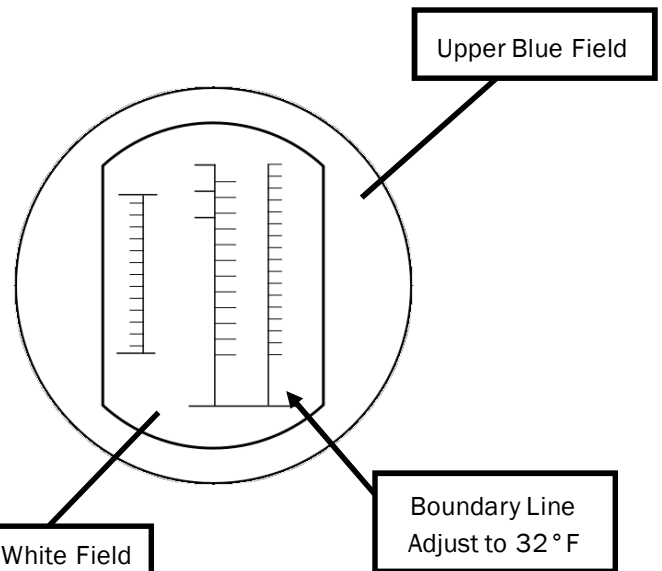
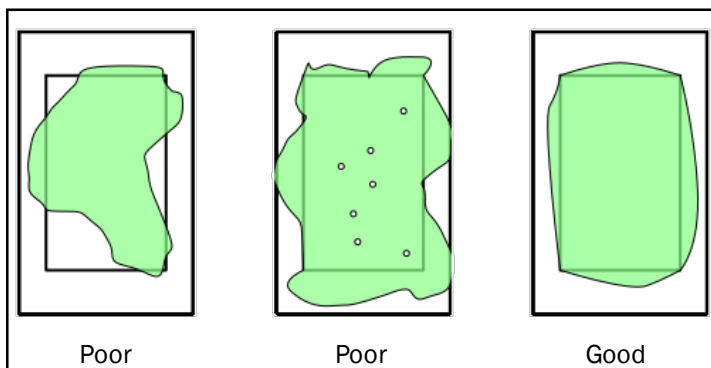

Antifreeze Types

The following information addresses the necessary usage of a propylene glycol based “boiler” type antifreeze in the Aqua-Hot. Propylene glycol is a safer alternative to the more toxic ethylene glycol antifreeze; however, as mandated by IAPMO (International Association of Plumbing and Mechanical Officials), only propylene glycol based “boiler” type antifreezes deemed “Generally Recognized As Safe” (GRAS) by the FDA should be utilized.

Due to the significant impact various types of antifreeze can have on a hydronic heating system, including the level of safety provided, it has been recognized that there is a need to provide an explanation regarding two additional prominent types of antifreeze/coolant available. The following information should be utilized as an educational means of ensuring that the proper type of propylene glycol based antifreeze is selected.

RV & Marine Antifreeze

These types of propylene glycol based antifreeze products are formulated specifically for “winterizing” applications only. Although RV & Marine antifreeze is often “Generally Recognized As Safe” by the FDA, **it should never be used in the Aqua-Hot’s Hydronic Heating System**. This type of antifreeze is not formulated to transfer heat, which is essential to the heating system’s functionality and does not contain rust inhibitors. Please note, however, that RV & Marine antifreeze can be utilized to winterize the Aqua-Hot’s Domestic Hot Water Heating Systems.

Automotive Antifreeze/Coolant

These types of propylene glycol based antifreeze products are formulated specifically to protect automotive engines against corrosion, freezing temperatures, and overheating. They also have excellent heat transfer and thermal conductivity characteristics. Although these types of antifreeze products are considered less toxic and safer than ethylene glycol for people, pets, and the environment, they are not “Generally Recognized As Safe” (GRAS) rated by the FDA. Therefore, they must be marked with a “harmful if swallowed” warning. This additional warning is required because these types of antifreeze products contain high levels of chemical rust inhibitors. Due to their potentially hazardous properties, they should never be used in the Aqua-Hot’s Hydronic Heating System.

Antifreeze Mixture Quality Recommendations

In order to ensure maximum performance and longevity of an Aqua-Hot heating system’s boiler tank and associated components, it has been determined that there is a need to use distilled, deionized, or soft water in combination with concentrated propylene glycol for the Aqua-Hot’s antifreeze and water heating solution.

Please note that this is only necessary when mixing concentrated propylene glycol antifreeze with water; suppliers of premixed antifreeze are responsible for the use of high-quality (distilled, deionized, or soft) water when preparing their antifreeze for sale.

Hard water possesses a high-level of calcium and magnesium ions, which deplete the propylene glycol antifreeze’s corrosion inhibitors. This, in turn, causes the antifreeze and water heating solution to begin turning acidic, which can corrode the Aqua-Hot’s boiler tank and associated components prematurely. Therefore, concentrated propylene glycol should be diluted with distilled, deionized, or soft water which is 80ppm or less in total hardness. The local water agency should have up-to-date water quality reports, which should indicate if the local tap water is within this guideline.

Antifreeze Terms & Mixture Ratio

Propylene Glycol Based Antifreeze Solution

The following information addresses the process of selecting a propylene glycol based antifreeze solution that provides adequate freeze, boiling, and rust/anti-corrosive protection.

A propylene glycol antifreeze solution that is 35% to 50% propylene glycol to distilled water is recommended. Antifreeze solution with 50% propylene glycol will result in a freeze point of approximately -28 °F and a boil point of approximately 222 °F.

Freeze Point and Burst Point

NOTE: The installer of the Aqua-Hot system must refer to the information and chart to determine the percentage of propylene glycol the antifreeze solution should contain for the level of protection needed.

Antifreeze solution lowers the freezing point of any liquid, to which it has added, by preventing the formation of ice crystals. However, as the ambient temperature continues to decline, the water in the solution will attempt to attain a solid state. The point in which the water begins to solidify is termed the “Freeze Point”. Although the water in the solution has begun to freeze and starts producing a “slushy” consistency, the antifreeze in the solution will continue to combat the normal expansion of the solution as it freezes. The point in which the solution can begin to expand, due to colder temperatures, is called the “Burst Point”. Once the solution reaches the burst point, the potential is present for ruptured pipes to exist. The burst point of the antifreeze and water heating solution is dependent upon the brand of propylene glycol antifreeze employed.

Rust and Anti-Corrosive Inhibitors

Another major function of antifreeze solution is to provide

protection to the internal metal components of the Aqua-Hot Hydronic Heating System from corrosion and rust. Antifreeze is able to perform this function by the addition of rust and anti-corrosive inhibitors, which are designed specifically to activate in a water solution.

Summary

Antifreeze solution has three basic functions: freeze protection, boil-over protection, and rust/anti-corrosion protection.

Propylene glycol antifreeze solution is also primarily responsible for heat transfer; however, propylene glycol itself does not possess acceptable heat transfer characteristics. Therefore, as water is an excellent heat conductor, it is added to the mixture. Propylene glycol antifreeze solution, mixed with distilled water, at a ratio of 35% to 50% is recommended to provide the best performance combination of the aforementioned functions. If excess propylene glycol exists within the heating solution, the water’s heat absorption properties are compromised. Ultimately, this could inhibit the Aqua-Hot from providing adequate domestic hot water and interior heating.

Additionally, if the antifreeze and water heating solution contains over 70% propylene glycol, the freezing point is actually

raised, resulting in less freeze protection. Please reference the attached graphical representation regarding the percentage of antifreeze to water and how it directly affects the solution’s freezing point.

In order to provide the best freeze protection, boil-over protection, anti-corrosion, and rust protection, a mixture of 50/50 “GRAS” approved **Propylene Glycol** antifreeze and distilled or de-ionized water is recommended. Reference Page 33 for measuring the antifreeze mixture with a refractometer and also the table below for the mixture ratios.

Propylene Glycol												
Freeze Point (°F)	0	-4	-7	-9	-12	-15	-18	-23	-29	-34	-40	-46
Concentration (%)	0	12	19	25	30	34	38	44	49	53	57	60

DANGER

Failure to utilize a propylene glycol which has been deemed Generally Recognized As Safe (“GRAS”) by the FDA could result in serious bodily harm to damage to the Aqua-Hot system.

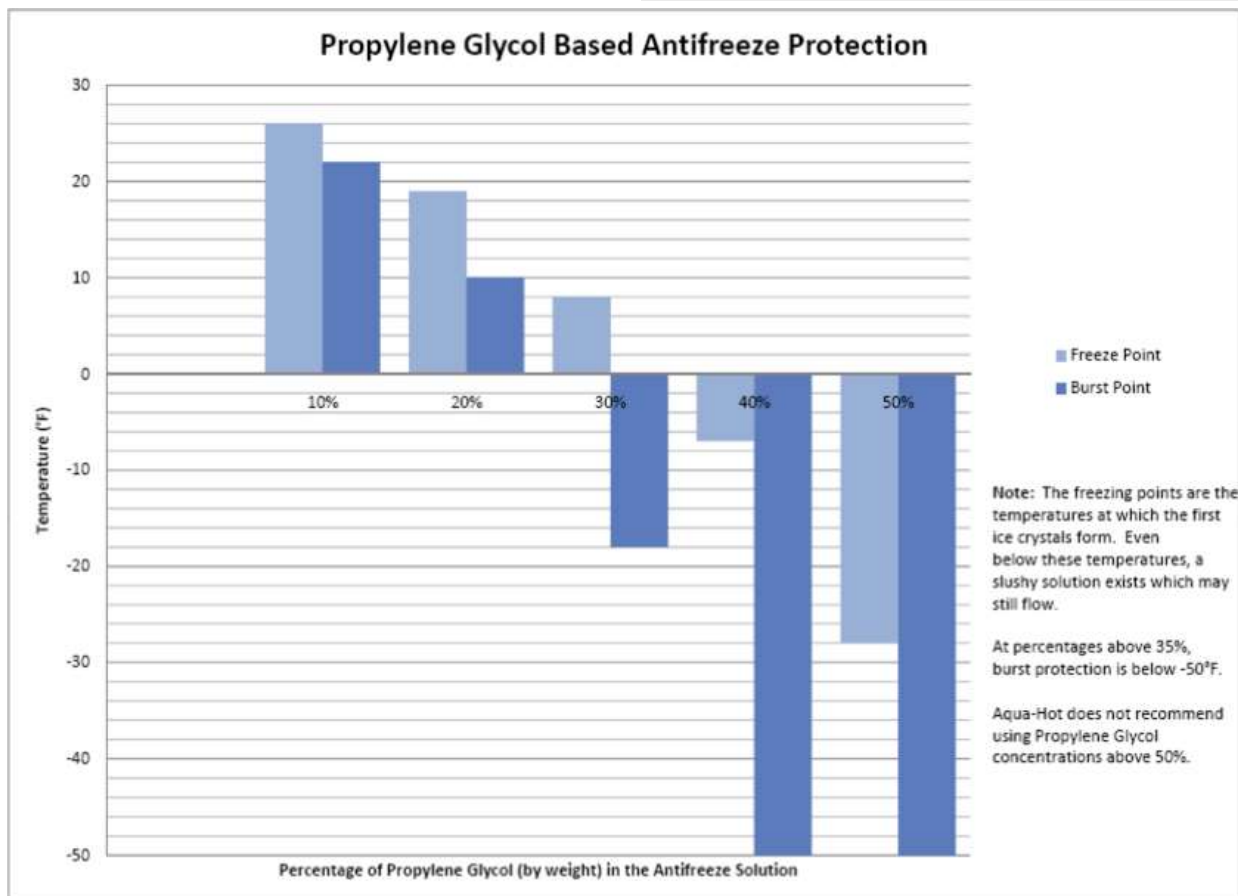



AHE-250-D01
250 Series Diesel w/ Electric Element (1kW @ 120V AC)



ELE-000-508
Panel, Switch, 2-Position ASM

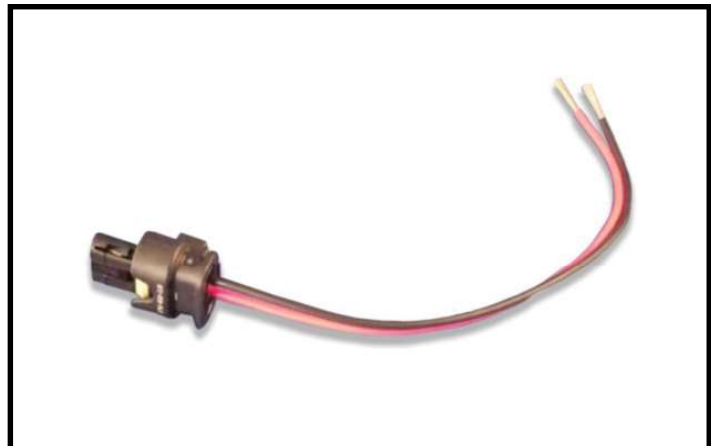

ELE-400-900
Boost Pump Harness



ELX-700-007
Room Thermostat, Positive Off



EXE-103-OEX
Heat Exchanger, Cozy III



EXE-505-65A
Heat Exchanger, Whisper Silent, 12V DC.



EXX-006-500
Grille, Long, 3.5" x 21.5", Black



EXX-013-100
Nozzle, Round 4" w/o Connector, Black



EXX-013-105
Nozzle, 4" Round w/ 2-1/2" Connector, Black



EXX-950-411
Grille, 10" x 2" Cozy



EXX-006-501
Grille, Medium, 3.5" x 15", Black



EXX-006-502
Grille, Small, 3.5" x 8.5", Black



MSE-200-OFB
Overflow Bottle Kit (Tank, Hose, Clamp, Tie, Labels).



PLX-000-200
Tube, 5/8" Safety Stripe, 12ft.



PLX-000-820
Fitting, Elbow, 90°, 3/4", Barb, Black Nylon



PLX-000-835
Fitting, Reducer 3/4" to 5/8" Black Nylon



PLX-100-836
Pump Mounting Bracket



PLX-100-900
Boost Pump



PLX-120-626
Tube, 5/8", Red O2 Barrier Pex 100 Ft.



PLX-200-103
Fitting 1/2" (M) NPT x 3/4" Barb Black Nylon



PLX-284-74V
Hose, Molded, Elbow 90°



PLX-432-000
Fitting, Straight, 1/2" PEX x 1/2" (M)NPT PSF



PLX-664-730
Fitting, Pipe Nipple, Exhaust, 1-1/2" x 4"



PLX-664-750
Fitting, Exhaust Nipple, 1-1/2" x 3" NPT



PLX-803-000
Fitting, Straight, 1/2" PEX x 1/2" (F) NPT



PLX-803-ELB
Elbow Fitting, 90°, 1/2" PEX x 1/2" PSF



PLX-803-FSE
Elbow Fitting, 90°, 1/2" PEX Fitting



PLX-CTB-270
Clamp, Hose, Constant Tension, 0.75"



PLX-A51-106
Bend Support, 5/8"



PLX-A65-200
Fitting, Brass Barb, 3/4" x 1/2" (M) NPT



PLX-A65-300
Fitting, Brass Barb, 90°, 3/4" x 1/2" (M) NPT



PLX-T44-006
Fitting, Insert Modified Bras



SME-102-000
Cozy Plenum Assembly

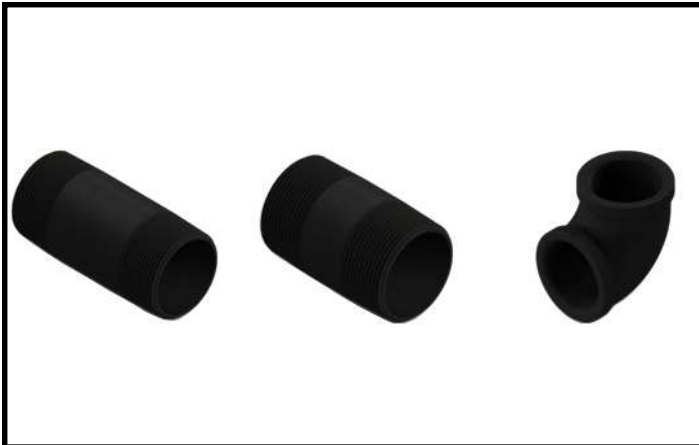

MSE-200-EXH
Exhaust Kit



MSX-300-270
Boiler Antifreeze, 1-gallon, Pink



MSX-300-300
Boiler Antifreeze, 1-gallon, Green



2-YEAR LIMITED WARRANTY AQUA-HOT® HYDRONIC HEATING SYSTEM

Aqua-Hot Heating Systems Inc. warrants the Aqua-Hot Heater to be free from defects in material and workmanship under normal use and service for a period of two years on both parts and labor commencing upon the original date of registration of the vehicle. Replacement parts are warranted for the remainder of the Heater's standard warranty coverage or for six months, whichever is greater. The intent of this warranty is to protect the heater's end-user from such defects, which would occur in the manufacturing of the product. Thus, problems due to improper specifications, improper installations, improper use, the use of accessory parts or parts not authorized by Aqua-Hot Heating Systems Inc., repair by unauthorized persons, and damage or abuse of the heater are specially excluded from warranty coverage.

For additional information, or to obtain a warranty repair authorization, please contact the Aqua-Hot Heating Systems Warranty Administrator at 574-AIR-XCEL (574-247-9235) (7:00 AM to 4:00 PM Mountain Standard Time) or visit www.aquahot.com.

My Comfort Zones are On-Board

Vehicle:

Purchased From:

Dealer Information:

Name:

Location:

Phone Number:

Heating System:

Serial Number:

Installation Manual

200_{SERIES}

 **Aqua-Hot**[®]
An AIRXCEL Brand



Aqua-Hot Heating Systems, LLC
7501 Miller Drive, Frederick, CO 80504

Visit us online at www.aquahot.com
Call us at 574-AIR-XCEL (574-247-9235)

©2022 Aqua-Hot Heating Systems, LLC. Printed in the USA