

Installation Manual

400 Series

 **Aqua-Hot**[®]
An AIRXCEL Brand

AHE-450-DE5
with

 Aqua-Hot 
REPORTER



Contents

Caution Notes.....	1
Introduction	2
System Features	4
Component Cut-Aways	5
Installing the Aqua-Hot	7
Support & Clearances.....	8
Installation of the Expansion Tank.....	9
Exhaust System.....	10
Installing the Heat Exchangers	13
Mounting the Heat Exchangers.....	15
Wiring the Heat Exchangers	16
Plumbing the Heating Loop	17
Heat Exchangers Layout.....	19
Engine Preheat.....	20
Diesel Fuel System.....	22
Domestic Water System Requirements	25
Plumbing the Domestic Water System	26
Thermostats	27
Switch Panel.....	28
Wiring the Aqua-Hot	30
Aqua-Hot Reporter.....	33
Reporter Manual Mode.....	37
Connecting the 450D to 12V DC Power	38
Connecting the 450D to AC Power.....	39
Filling the Aqua-Hot.....	40
Purging the Interior Heating Loop.....	41
First Operation.....	42
Winterizing	43
Flow Diagram.....	44
Wire Sizing	45
Appendix A: System Schematics	46
Appendix B: Antifreeze.....	52
Appendix C: Parts & Accessories	55
Warranty	61

Caution Notes

As you read this information, take particular note of the NOTICE, CAUTION, WARNING and DANGER symbols when they appear. This information is important for safe and efficient use of the Aqua-Hot system.

NOTICE signals a situation where potential damage to the Aqua-Hot could occur.



CAUTION signals a situation where potential harm or risk of minor or moderate injury could occur if you do not follow instructions.



WARNING signals a hazardous situation where potential harm, risk of serious injury, or death could result if instructions are not followed.



DANGER signals a situation where immediate risk of serious injury or death will result if instructions are not followed.



NOTE: This manual will also use notes sections similar to this one to draw attention to features and practices which should be observed.

Read all instructions before installing the Aqua-Hot unit. Aqua-Hot Heating Systems is not liable for damage resulting from failing to follow instructions contained in this, and any other Aqua-Hot documentation relevant to this unit.

- Read this manual before installing or using the Aqua-Hot System to reduce the risk of injury to persons or damage to the equipment.
- The product identity label contains specifications of the unit, to what standards it has been tested, and important safety notices.
- Disconnect electric wiring to the Aqua-Hot System before welding or plasma cutting the coach to avoid damage to equipment.
- The Aqua-Hot tank and heating loop operate at 0.0 PSI (zero pressure system). Air pressure to the tank must not exceed 20 PSI. Exceeding this rating will cause internal damage to the Aqua-Hot.
- Use caution when working on or near any propane/diesel fuel system.



- DO NOT connect the 12-volt DC power to the Aqua-Hot if the vehicle requires welding.
- At maximum operating temperature, the coolant will be very hot and scalding. Hot vapor or coolant may cause in serious burns or injury. Be aware of hot surfaces.
- Installation and repairs may only be carried out by an authorized, factory-trained Aqua-Hot technician. The heating system must be installed in accordance with local codes, or in accordance with the Standard for Recreational Vehicles, (RVIA) ANSI A 119.2/NFPA 501C, NFPA 1192.
- Aqua-Hot will not be liable for problems or damage caused by the system being installed by untrained personnel.

NOTE: For networked control of the Reporter, Aqua-Hot requires system integrators ensure that individual commands are received and processed. Aqua-Hot requires that commands be repeated or confirmed so that if a single message were dropped, or if there is a brief network disturbance, the Reporter would get into the correct state as soon as the disruption was removed.

The Aqua-Hot Reporter monitors the heating system and handles all logic relating to safeties and heating control. As such, the system integrator is required to display all pertinent status information but not use that information to lock out operation or add additional safety layers that could impact the end of operation if a message from the Reporter was missed.

Safety Features

Low-Voltage Shutdown

The Aqua-Hot Reporter is designed to operate between 11V DC and 16V DC. If the Reporter detects that it is receiving voltage below 11.8V DC, a System Voltage fault will trigger a display on the screen. If the Reporter system drops below 11.2V DC for 30 seconds, it will discontinue operation of the Aqua-Hot heating system.

Over-Current

An Over-Current fault condition occurs when too much current is drawn by a component, usually a fan or pump. When this fault is triggered, the output channel is shut off until the system has been reset or power-cycled.

Over-Temperature

An over-temperature fault will occur if your Aqua-Hot heating system has reached 218°F. The Reporter will deactivate the heater and display an over-temperature fault on the display screen.

Low-Level Cutoff

If the system senses low fluid levels, the heating system will shut down all fans, heat sources, and pumps until the unit is adequately refilled.

Reporter “Heartbeat Function”

The Reporter units with firmware 1v5 and later and all Reporter 2.0 units are equipped with a “heartbeat” function that establishes a signal between the RV-C system and the Reporter. The Reporter constantly awaits for a signal from the RV-C network indicating to the Reporter that it is to continue normal operation. Loss of 6 consecutive signals from the RV-C network will trigger the Reporter to deactivate the Aqua-Hot. Once power is restored to the coach and the Reporter, “BATTERY DISCONNECT SWITCH OFF” will be displayed in the fault log, indicating that the Reporter lost connectivity with the RV-C network.

Manual Mode

The 2.0 Reporters with CFG 1.9 and greater come with a manual mode in case the general coach RV-C network fails. It will allow for limited operation while the larger network/module problem is addressed.

Interlock Switch

The Aqua-Hot 450D is equipped with an interlock switch that prevents the heater from operating when the cover is not installed in the correct position or if it is not properly secured in place. This is a safety device to ensure the burner will not ignite if the service panel is not properly secured.



System Overview

The Aqua-Hot 450D is a Hydronic (water-based) Heating System, a tank-less hot water system, and a diesel engine preheating system.

The heating system provides moist, quiet, comfortable, interior heat with up to 5 separate, thermostatically-controlled temperature zones, and prevents tank and line freezing in the bays.

The tank-less hot water system produces 90 gallons per hour of continuous, on-demand hot water.

The diesel engine preheating system circulates the engine's antifreeze solution through an internal heating loop in the Aqua-Hot and pumps it back through the engine, raising the engine's temperature from 30°F to 90°F in about 1 hour.

The same heating loop that preheats the diesel engine allows the Aqua-Hot system to take surplus heat generated by the motor home's diesel engine while running, and use it to heat the Aqua-Hot system.

This TribridHot™ designated system uses one or a combination of heat sources to heat FDA-Approved Generally Recognized As Safe ("GRAS") Propylene Glycol-based antifreeze solution in the Aqua-Hot's boiler tank.

The 450D has multiple heating sources: the motor home's engine's surplus heat (while driving), one 120V AC - 1650W Electric Element (when plugged into shore power), and a 12V DC powered diesel burner (when dry camping). These heat sources can be used separately or simultaneously.



New Low Emissions Technology virtually eliminates smoke and odor from the exhaust by reducing total hydrocarbon emission by 82%, making Aqua-Hot the cleanest burning diesel-powered hydronic heating system available.

Should additional assistance be needed, please contact the Technical Support at 574-AIR-XCEL (574-247-9235), Monday through Friday, between 7:00am and 4:00pm MST.



Important Notes:

- A qualified installer or service technician must perform equipment installation or service. Contact Aqua-Hot for Factory Authorized Service Centers or Certified Technicians located near you at www.aquahot.com/service-help, or call us at 574-AIR-XCEL (574-247-9235).
- Warranty work must be performed by an Aqua-Hot Authorized Service Center.
- Your on-product identity label contains the specifications of your unit. Factory settings may be adjusted by the vehicle manufacturer, confirm final setting with your dealer.
- This heating system has been certified for installation only in recreational vehicles, not certified for use in boats.
- The Aqua-Hot heating system operates independently of the vehicle engine and is connected directly to the electrical system of the vehicle.
- Please read this manual and follow instructions to avoid injuries during installation and/or operation.

Hot Water Priority System

The Aqua-Hot 450D is a Hot Water Priority heating system. Meaning that the 450D cannot heat the interior of the coach and produce hot water simultaneously. When hot water is being used, the interior heating system will shut off temporarily, until hot water is no longer being used.

When hot water is requested, domestic water from the coach's fresh water tank is transported through a copper coil in the Aqua-Hot's boiler tank where heat is transferred from the heated antifreeze and distilled water solution. The heated domestic water then flows through the tempering valve to be mixed with cool water from the fresh water tank to achieve an appropriate temperature before it flows to the faucet.





For installation only in a compartment that is completely closed off from living quarters and accessible only from the outdoors. Exhaust system MUST NOT terminate beneath the vehicle and not less than 3 feet from an openable window.

Combustion Air MUST BE supplied from outside the vehicle.

THIS APPLIANCE OPERATES ON BOTH AC AND DC POWER.

USE COPPER CONDUCTORS ONLY!

Use a 25-Amp fuse for over-current protection for the DC power supply.

Use a circuit breaker that cuts power at 20-Amps maximum for over-current protection for the 120-VAC power supply.

Mount the Heater near a bay/storage door so that the Access cover can be easily removed for service.

For Detailed Information, reference the Owner's Manual or contact Aqua-Hot Heating Systems Inc. at 574-AIR-XCEL (574-247-9235.)

Minimum Heater Clearances
 Front - Open Access
 Back - 0 Inches
 Top - 0 Inches
 Sides - 0 Inches

This appliance must be installed in accordance with local codes or, in the absence of local codes, the Standard for Recreational Vehicles, NFPA 1192 or CAN/CSA-Z240 RV.



For Direct Vent Installation in a Recreational Vehicle.

Meets or Exceeds: UL 307A, UL 174
 CSA/CAN B140.0-03
 CAN/CSA-C22.2 No.110-94

Max Tank Pressure	0 PSI
Max Watts (DC)	174
Max Watts (AC)	1650
Nozzle Size/Angle	.35/60
Volts	12 VDC
Volts	120VAC, 60Hz
Pump Pressure	145 PSI / 10.0 bar
Input Firing Rate	56,000 BTU/hr / 16.4kW.
Diesel Burner Model	Webasto
Fuel Type	DIESEL

Diesel Burner Serial Number: 106642
 Model Number: AHE-450-DE5
 Heater Serial Number: A450D-1850005

7501 Miller Drive • Frederick, CO 80504 • 574-AIR-XCEL • www.aquahot.com

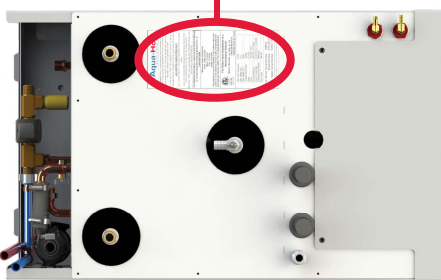

Figure 1

NOTE: This product label is attached to the top of the Aqua-Hot, and provides a ready reference to specifications, test standards, and important safety notices.



Figure 2

System Specifications

Diesel Burner

Heat Input (Firing Rate) 56,000 BTU/hr
 Fuel Consumption 0.40 gal/hr

Electric Element

Power Consumption 1650 W (maximum)
 Voltage 120V AC

DC Power

Consumption 174 W (maximum)

Zone Heat Circulation

Pumps 2
 Power Consumption (max) 21 W (each)
 Voltage 12V DC

Heating Zones

Maximum 5 + Engine Preheat

Domestic Water Heating

Maximum 1.5 GPM On-demand

Physical Specifications

Dimensions (US) 12" H x 18.5" W x 29.5" L
 Dry Weight 127lbs.
 Wet Weight 185lbs.

All vehicle installations must comply with the requirements listed in the Recreational Vehicle Industry Association's (RVIA) ANSI/NFPA 1192 Handbook for Recreational Vehicle Standards. To receive a copy of this handbook and other Pertinent RVIA Standards, write to: Recreation Vehicle Industry Association, 1896 Preston White Drive, PO Box 2999, Reston, VA 22090-0999. Call them at (703) 620-6003 or visit online at www.rvia.org.

- | | |
|-----------------------------|-------------------------------------|
| 1. Drain Valve | 14. Wiring Harness & Harness Port |
| 2. Zone 1 Circulation Pump | 15. Aqua-Hot Reporter |
| 3. Zone 2 Circulation Pump | 16. Domestic Water Coil |
| 4. Diesel Burner Controller | 17. Heating Loop Coil |
| 5. Combustion Air Sleeve | 18. Engine Preheat Outlet |
| 6. Diesel Burner | 19. Engine Preheat Circulation Pump |
| 7. Diesel Fuel Lines | 20. Engine Preheat Inlet |
| 8. Interlock Switch | 21. Domestic Cold Water Inlet |
| 9. VAC Access Panel | 22. Domestic Hot Water Outlet |
| 10. AC Terminal Block | 23. Tempering Valve |
| 11. AC Terminal Port | |
| 12. Heating Zone 1 Outlet | |
| 13. Heating Zone 2 Outlet | |



Figure 3

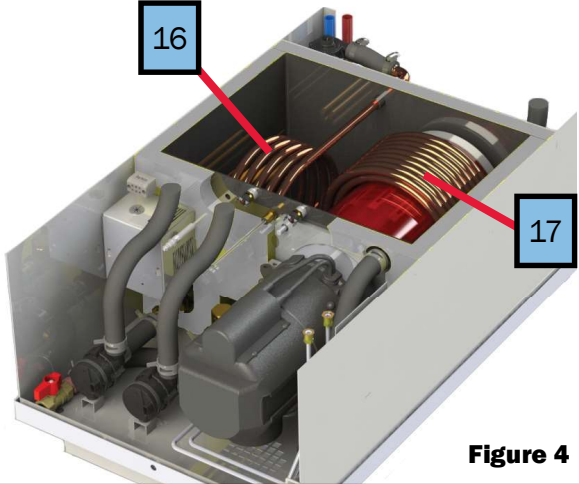

Figure 4

NOTE: The top panel has been made transparent in the view above to aid in the explanation of the heater. DO NOT remove the top panel. Doing so risks irreparable damage to the Aqua-Hot. Only remove the service panels.

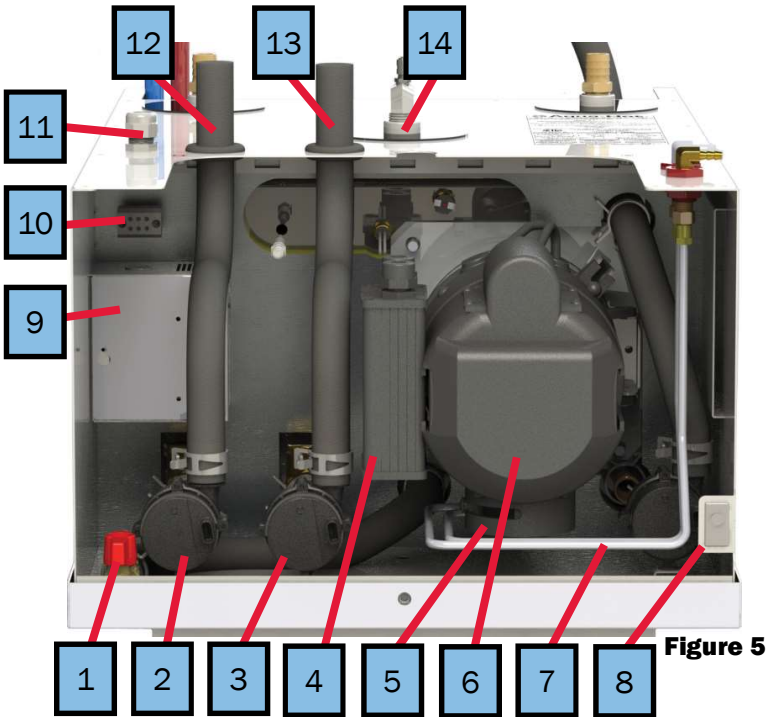

Figure 5

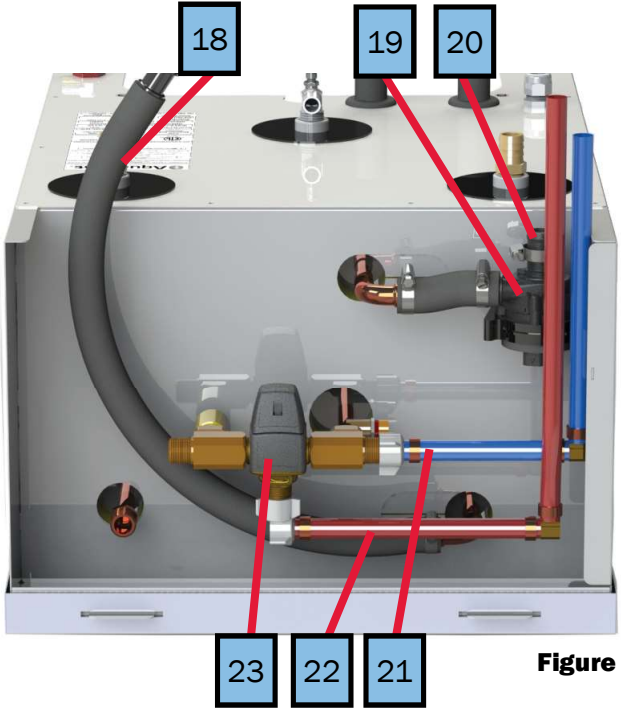

Figure 6

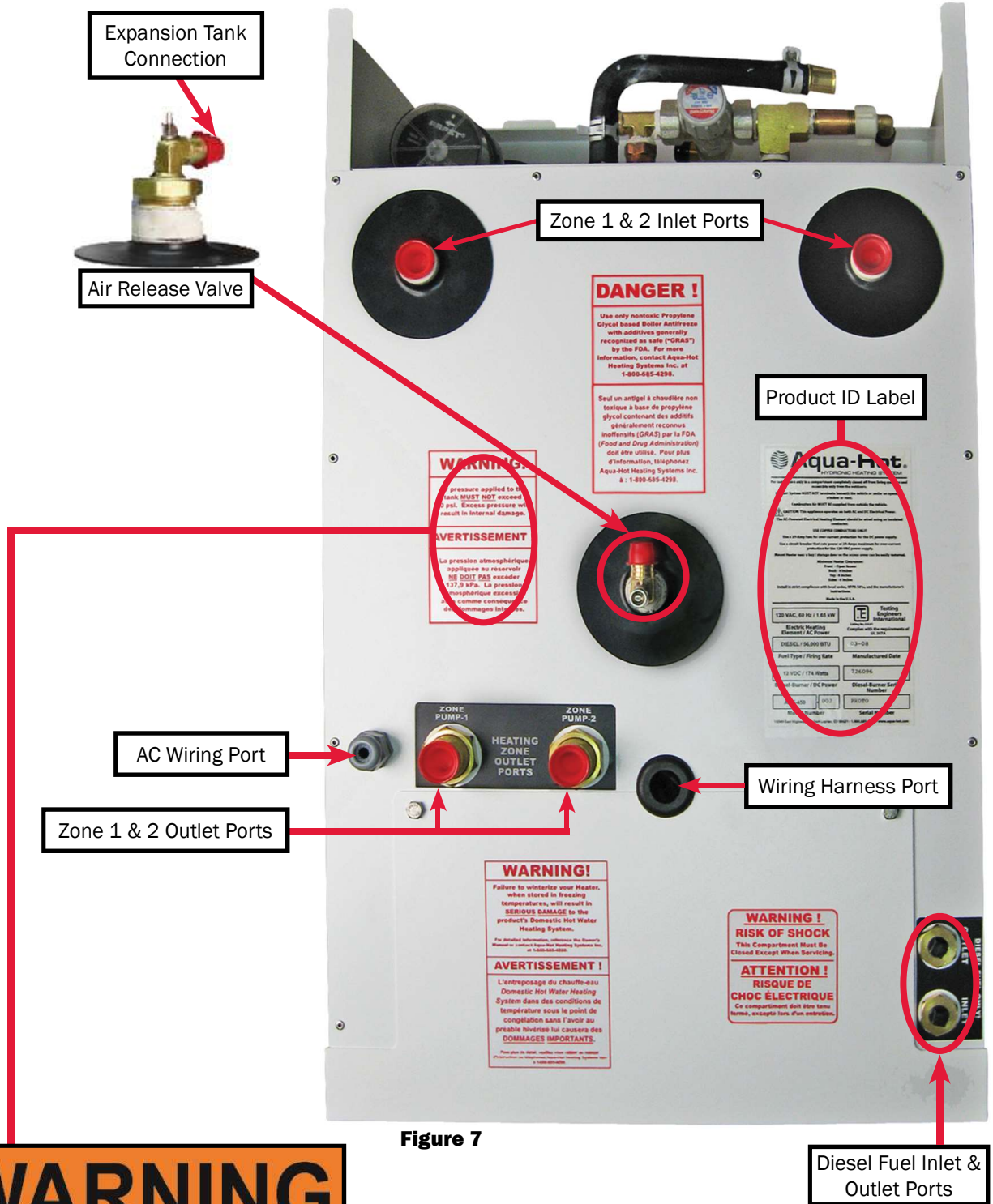

Figure 7

WARNING

The Aqua-Hot tank and heating loop operate at 0.0 PSI (zero pressure system). Air pressure applied to the tank **MUST NOT** exceed 20 PSI. Excess pressure will result in internal damage.

Installing the Mounting Tray & Aqua-Hot

Install the Aqua-Hot in a compartment that is completely closed off from living quarters and is accessible only from the exterior of the coach.

1. Reference the following illustrations below for mounting information.
2. Cut out the required mounting tray as shown in Figure 8.
3. Install the mounting tray flange into the cut out opening. Reference Figure 9.
4. Insert a #10 machine screw into each of the embossed holes in the mounting tray (6 total), and tighten to secure the mounting tray to the coach.

NOTE: Inspect the area near the mounting location to ensure that no structural members will interfere with the cut-out for the mounting tray.

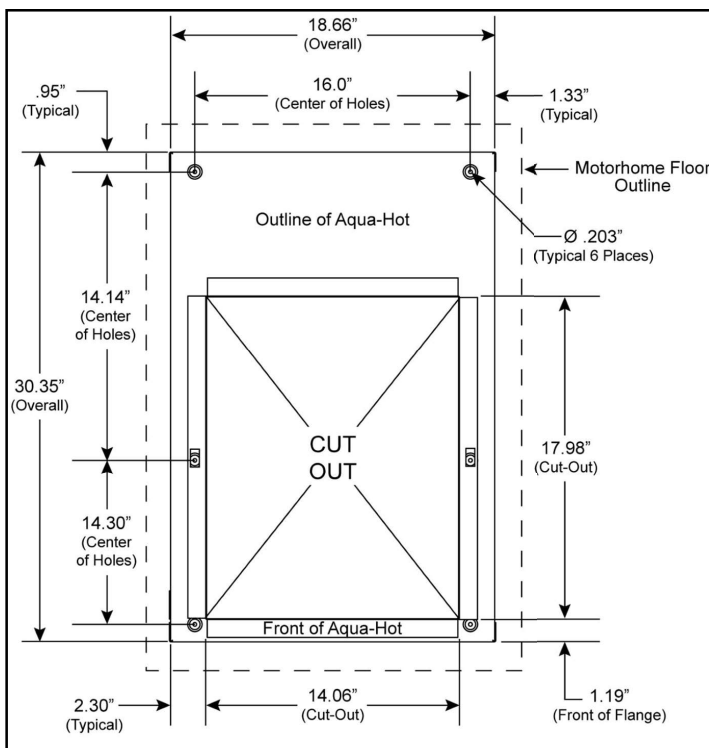
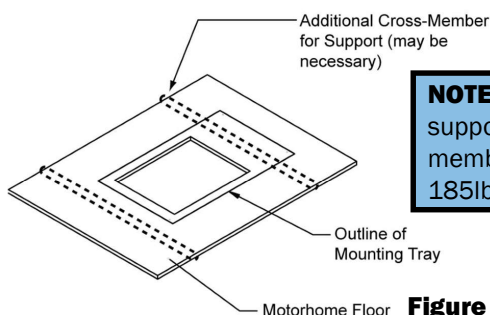

Figure 8



NOTE: The Aqua-Hot must be supported by structural cross-members that can support at least 185lbs.

Figure 9

5. Secure the mounting tray into place prior to installing the Aqua-Hot.
6. Place the Aqua-Hot securely into the mounting tray to ensure that the unit does not move or shift under normal operating conditions. Reference Figure 10.

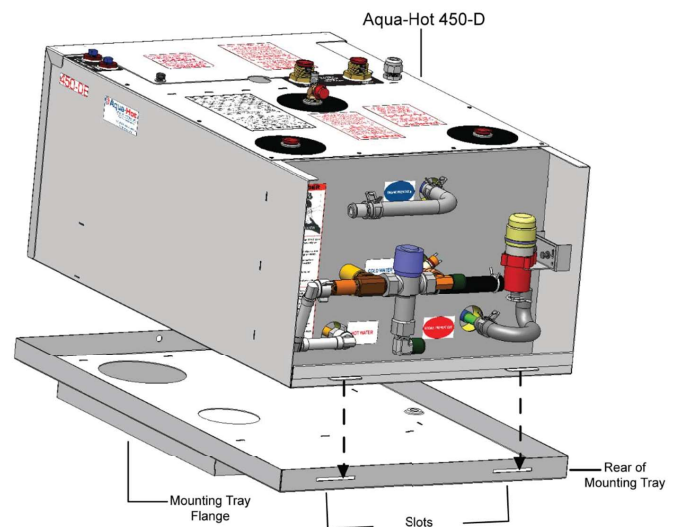

Figure 10

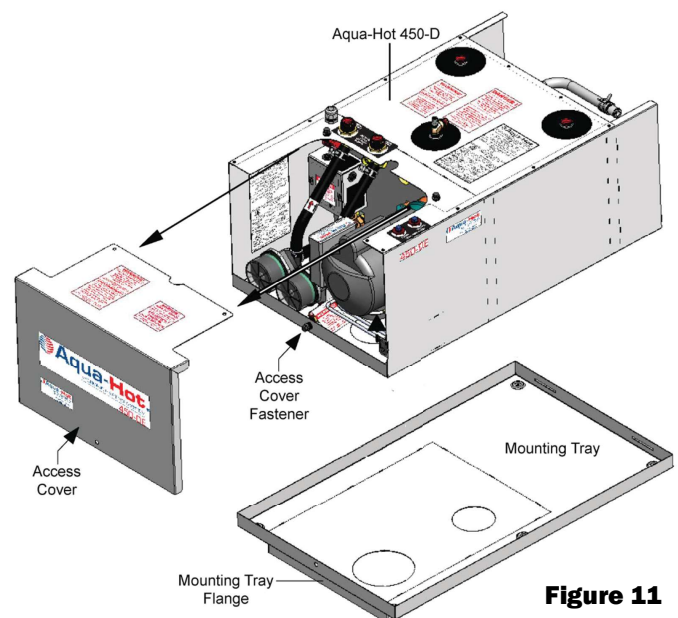
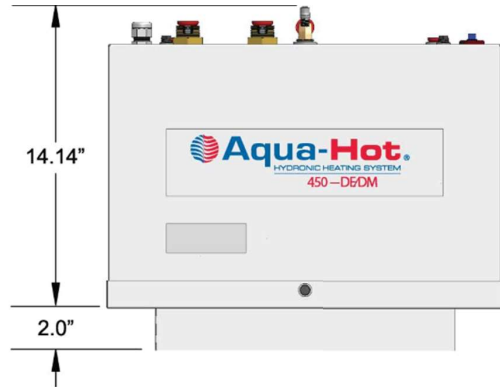
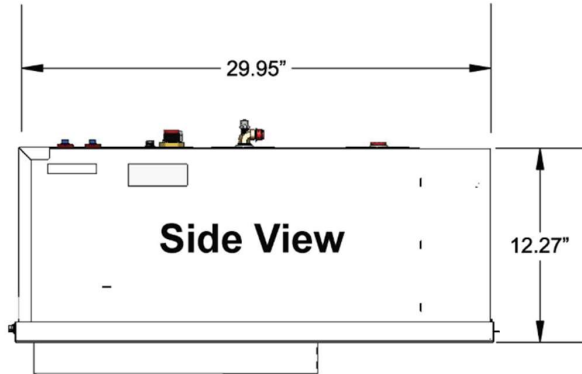
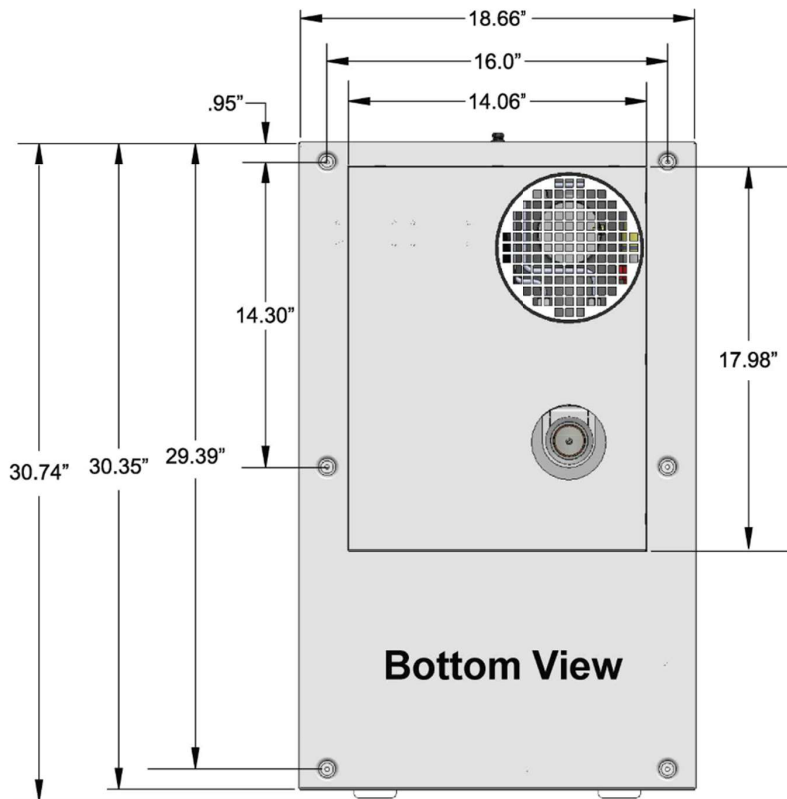

Figure 11

NOTE: Remove the bolt securing the front of the access cover to the mounting tray. This bolt will need to be reinstalled once the total installation procedure is complete.



Front View



All measurements
are in inches

Top View

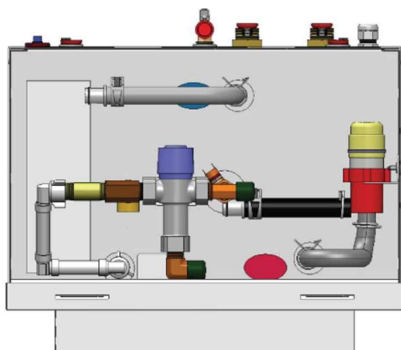
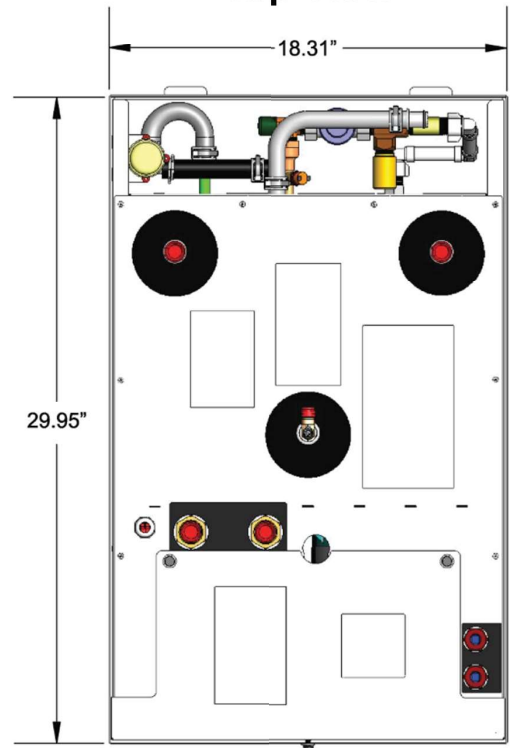

Installation of the Expansion Tank

Introduction:

The fluid expansion tank is integral to the operation of the Aqua-Hot. It provides an area for hot, expanded fluid to empty into, and also protects the Aqua-Hot from low-fluid, which could lead to catastrophic damage of the Aqua-Hot.

Follow the directions in this section to correctly install the fluid expansion tank.

Installation Procedure:

1. Mount the expansion tank as illustrated in Figure 13. The overflow tube should have an incline.
2. Connect and clamp the overflow tube from the expansion tank to the Aqua-Hot's expansion tank connection as shown in Figure 13.
3. Drill a hole in the bay floor and connect a long enough piece of overflow tubing so that it can be connected to the top of the expansion tank and extend through the bay floor. Secure tubing with clamps.

NOTE: The top of the expansion tank must be mounted higher than the highest point on the Aqua-Hot.

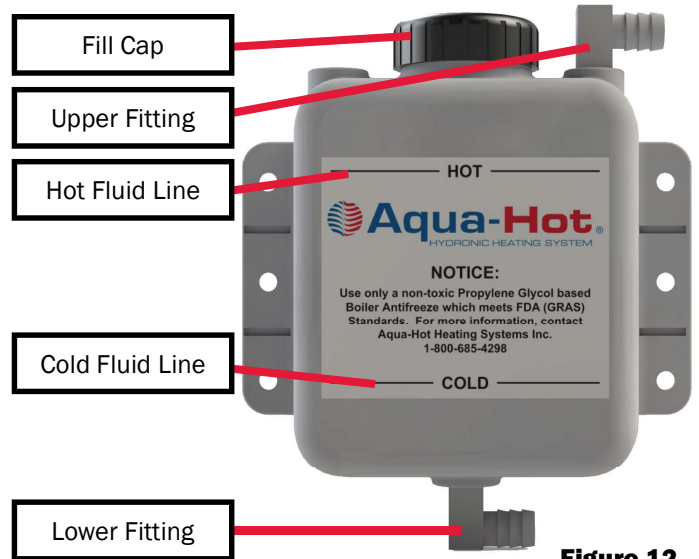

Figure 12

NOTE: Avoid any bends or dips in the overflow tubing from the Aqua-Hot. Air can become trapped in these bends and will prevent excess antifreeze and water heating solution from depositing properly in the expansion bottle.

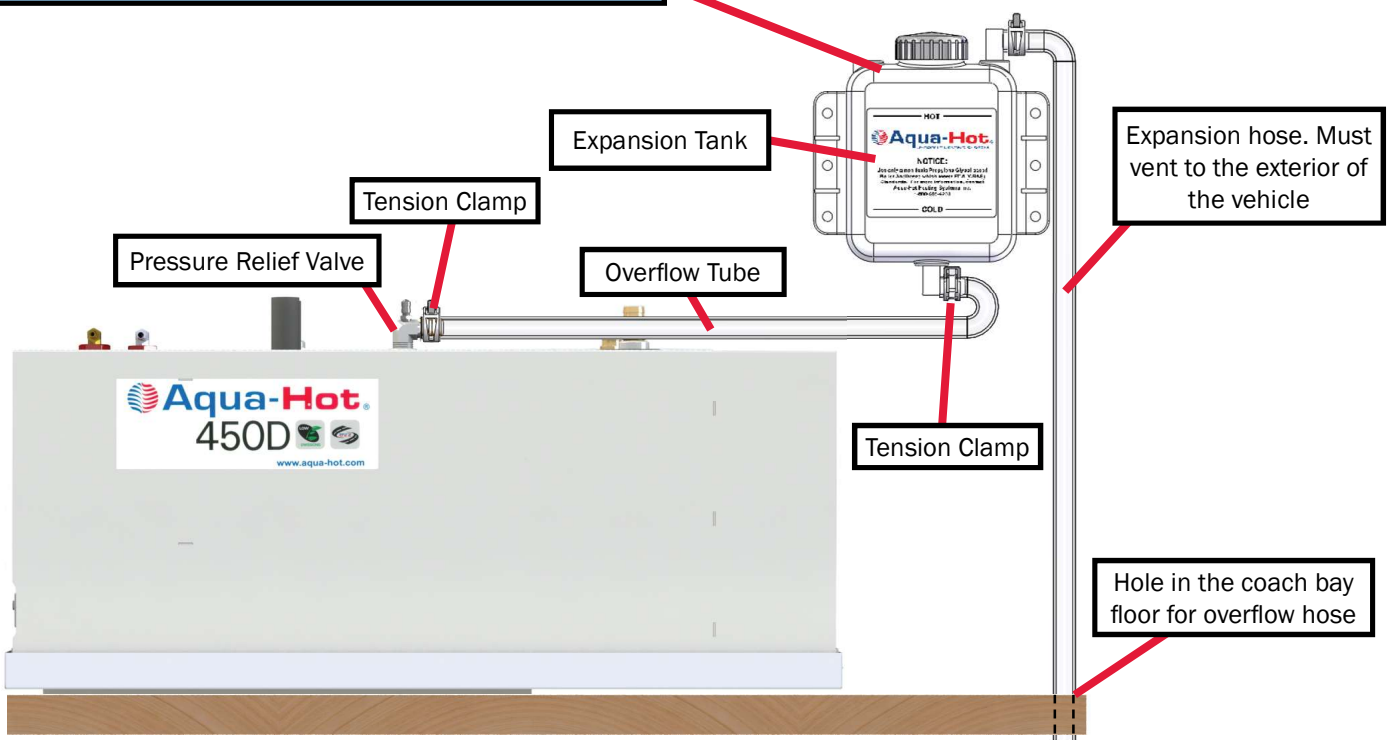

Figure 13

Exhaust System Requirements



CAUTION

The Aqua-Hot's exhaust is HOT and must be kept away from any heat sensitive material(s). Do NOT direct exhaust downward as a fire may result when parked in dry, grassy areas.

- The exhaust must be able to freely exit away from the vehicle without any obstructions.
- Angle the exhaust pipe towards the rear of the vehicle, so that exhaust fumes will naturally move away while the vehicle is in motion. See Figure 16.
- Use standard 2" automotive-type exhaust piping and avoid bends, if possible. A minimum 1.75" ID automotive-type exhaust pipe may be used. See Figure 15 & Figure 18.
- A maximum of three 90° exhaust bends are allowed. Reference Figure 15.
- Do not use galvanized pipe fittings (only black-iron pipe and fittings should be used). Reference Figure 18.
- The total length of exhaust pipe should not exceed 27.5 feet.
- The Aqua-Hot is supplied with a 3 inch and 4 inch black pipe nipple (1.5 inch diameter) along with a 1.5 inch exhaust elbow. Reference Figure 16. These three exhaust system components **MUST BE** utilized with all product installations. Be sure to reference Figure 17 and 18 to determine which exhaust nipple should be connected directly to the Aqua-Hot's exhaust port (the 3 inch of the 4 inch black pipe nipple).

NOTE: Refer to "Internal Combustion Engine Exhausts and Vehicle Wall Openings" in RVIA's ANSI/NFPA 1192 Handbook for the Recreational Vehicle Standards, as well as the National Fire Protection Associations' (NFPA) 1192 Standard on Recreational Vehicles for additional information.

Installation Procedure:

NOTE: Should this particular application require more than 27.5 feet of exhaust pipe, please contact Aqua-Hot at 574-AIR-XCEL (574-247-9235) for assistance.

1. Run the exhaust pipe to the driver's side or to the back of the vehicle and ensure that the exhaust fumes cannot enter into the passenger compartment.
2. Be sure to secure the end of the exhaust pipe to the vehicle with the proper exhaust hanger/support hardware.



CAUTION

All Aqua-Hot exhaust system installations MUST utilize the two black pipe nipples and black pipe elbow, which are provided with the heating system in the configuration to be suited for the particular RV application. Failure to conform could create a hazardous situation and WILL void the Aqua-Hot's ETL Product Listing.



Figure 14

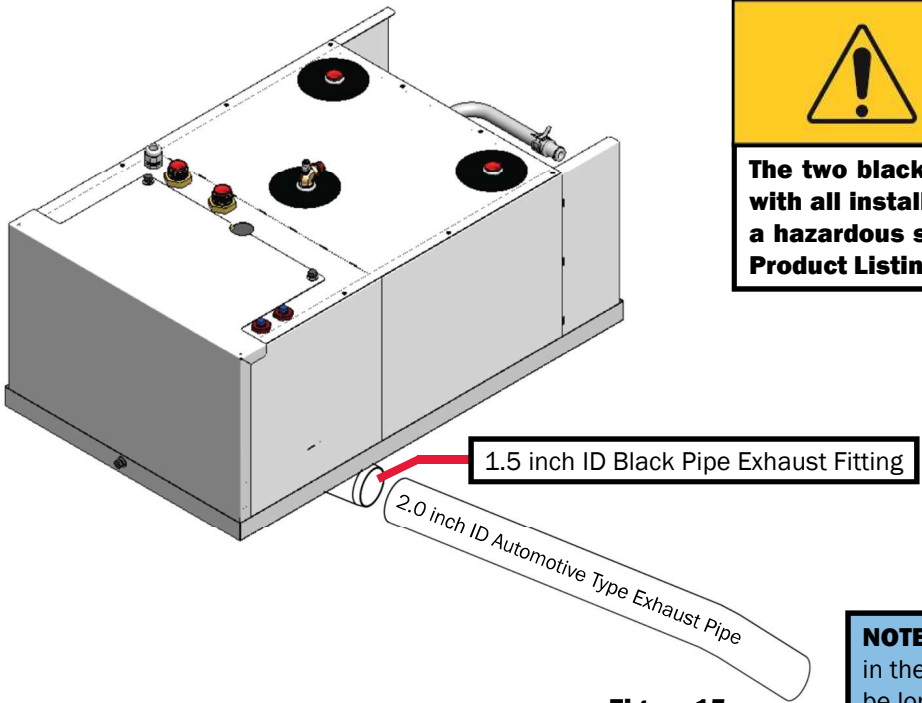

Figure 15

CAUTION

The two black pipe exhaust fittings **MUST** be utilized with all installations! Failure to conform could create a hazardous situation and will void the Aqua-Hot ETL Product Listing.

NOTE: A maximum of three 90° bends are allowed in the exhaust pipe. Also, the exhaust pipe cannot be longer than 27.5 feet.

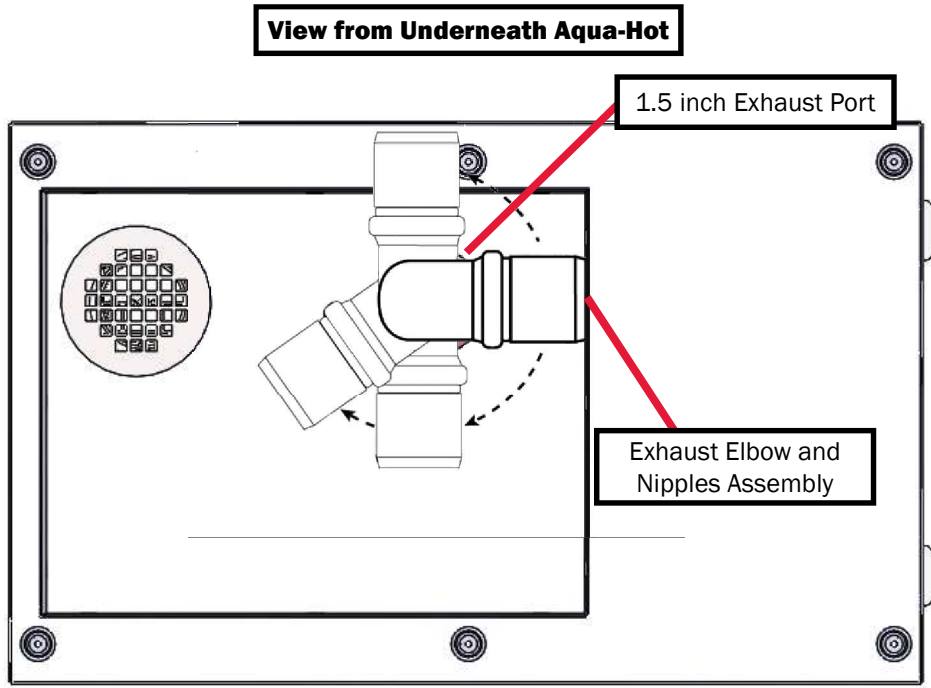

Figure 16

NOTE: The exhaust elbow can be rotated 270°, as shown in the illustration; however, the exhaust must not terminate beneath the vehicle or beneath an open-able window or vent.

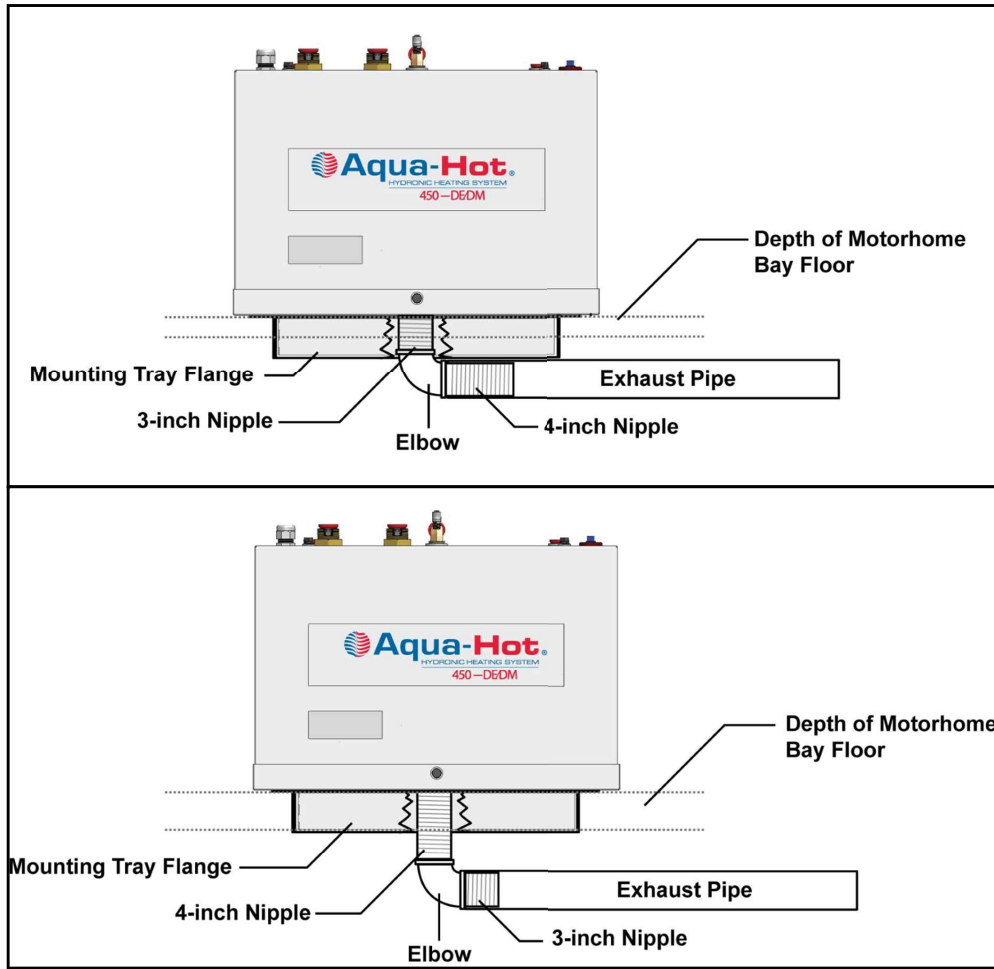

Figure 17

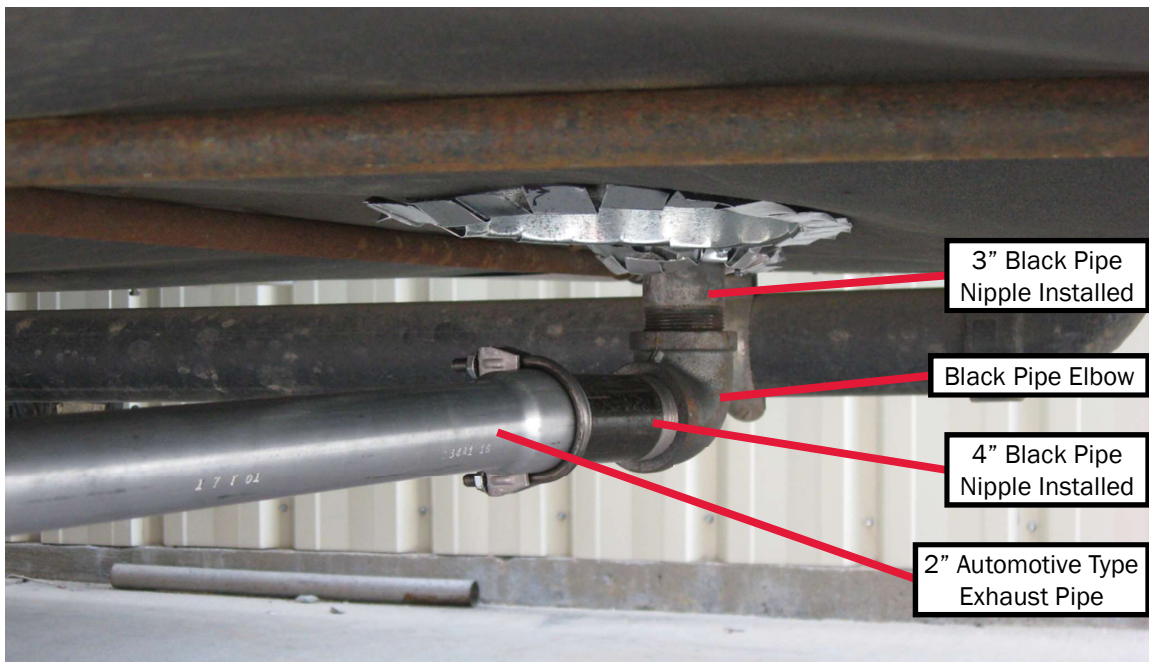

Figure 18

Installation Requirements

Cozy heat exchangers can be mounted in one of two configurations: either flat on the ground, or vertically. Reference Figure 19.

- Supply ventilation cross-sectional area of at least 29in² (74cm²) must be supplied to each heat exchanger.
- Do not supply heat exchangers air which is drawn from the bay areas; air supply should only be from the living areas.
- Return air should be drawn from the same room the heat exchanger is heating.
- The antifreeze and water heating solution must flow in through the bottom of the heat exchanger, and out the top (reference Figure 22).
- In order to provide sufficient ventilation, the return air registers must be the same size, or larger, than the outlet air registers.

NOTE: Do NOT install more than four heat exchangers per heating loop. If additional heat exchangers are required, use a booster pump (not included) to provide additional antifreeze flow capability.

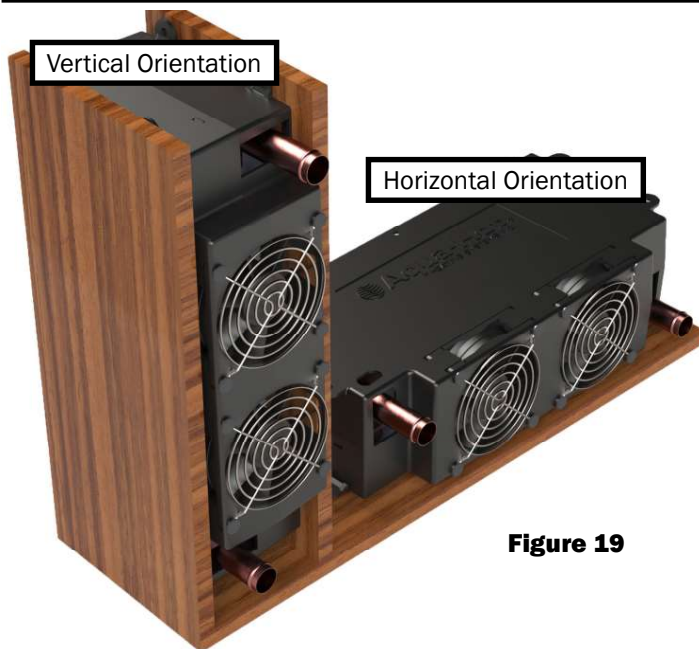

Figure 19

NOTICE

Aqua-Hot advises against placing a heat exchanger on the slide-out section of any vehicle due to the high probability of damage occurring to the heating loop from moving parts.

Heat Exchanger Locations and Clearances

- Position the heat exchangers so that even heat is distributed throughout the coach interior.
- The first heat exchanger on the loop will output the most interior heat.
- It is best practice to place the heat exchanger in an area where it can be easily accessed for maintenance and cleaning.
- Place the heat exchangers as close to the floor as possible for best performance.
- If a heat exchanger is kept in the fresh water storage bay, then the last heat exchanger in the coolant loop should be used. See Figure 20.
- The heating air supply may be fresh or recirculated air that is drawn from a clean area not likely to be contaminated.

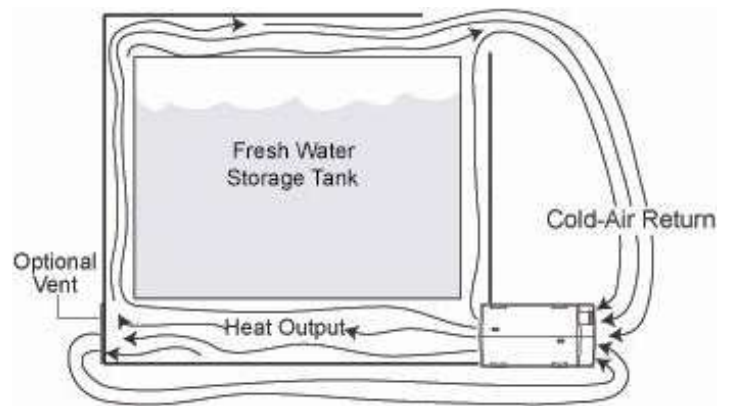

Figure 20

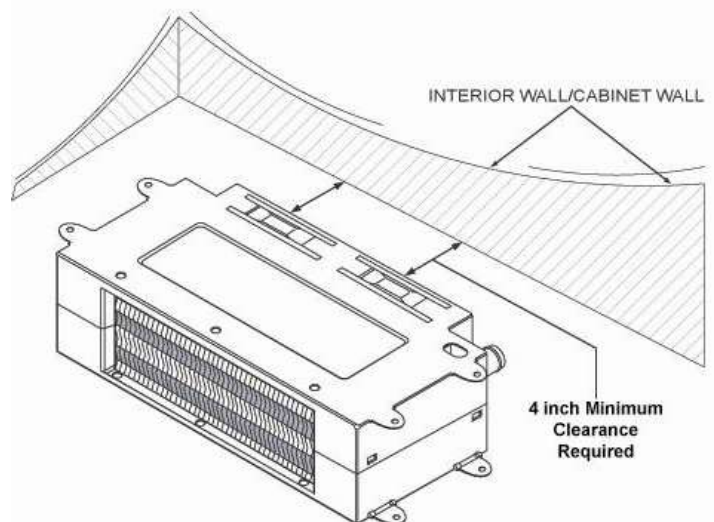

Figure 21

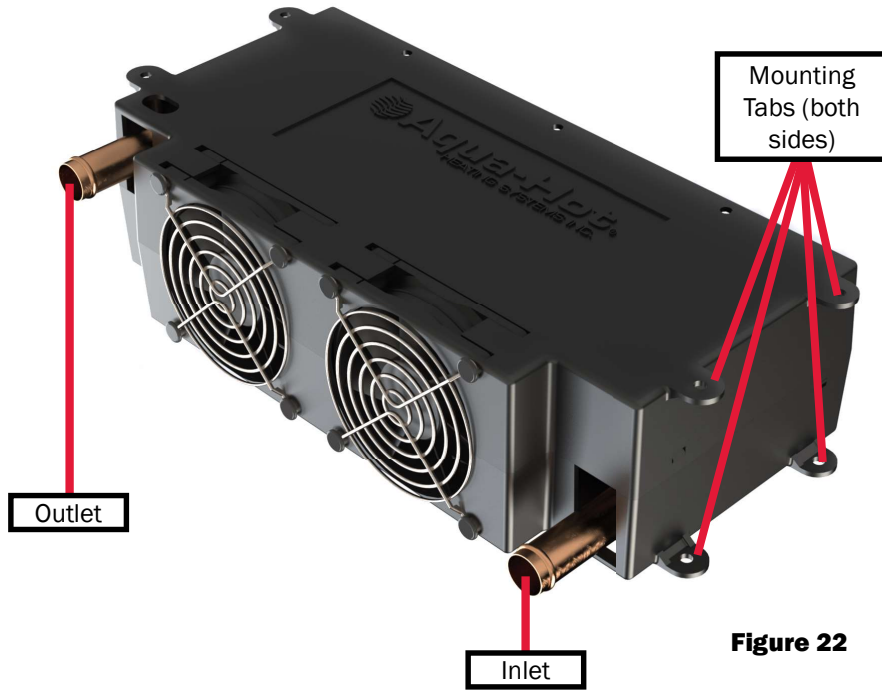

Figure 22

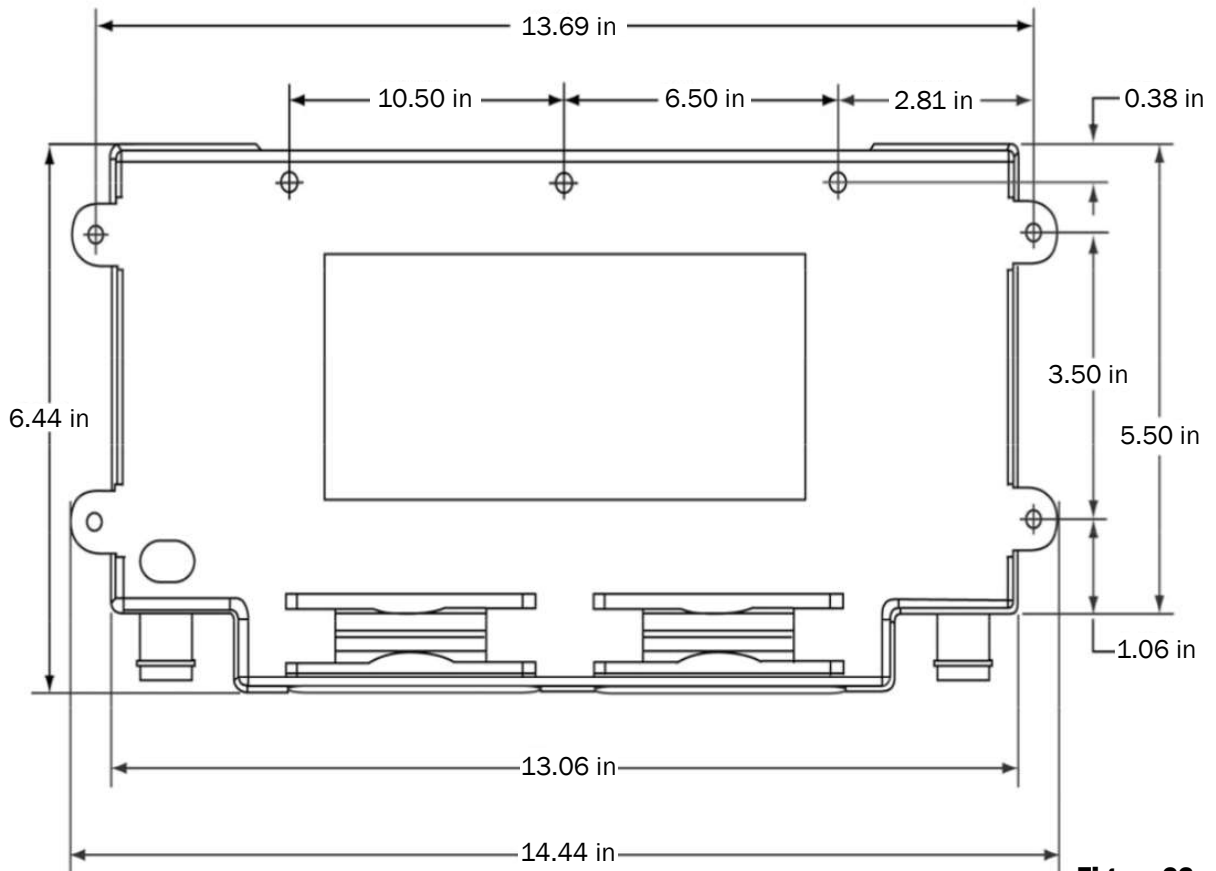

Figure 23

Mounting the Heat Exchangers

1. Cut out a 2.5" H x 10" W (7cm x 26cm) opening for each heat exchanger outlet and cold-air return grate as shown in Figure 25.
2. Mount each heat exchanger permanently into place. There are 4 tabs on both sides - see Figure 22.
3. Install the hot-air outlet and cold-air return grate.

A minimum of supply ventilation cross-sectional area of at least 29in² (74cm²) must be supplied to each heat exchanger.

If the toe-kick area is inadequate to house a heat exchanger for regular installation, a plenum assembly may be purchased to redirect air via ducting. Refer to Figure 26.

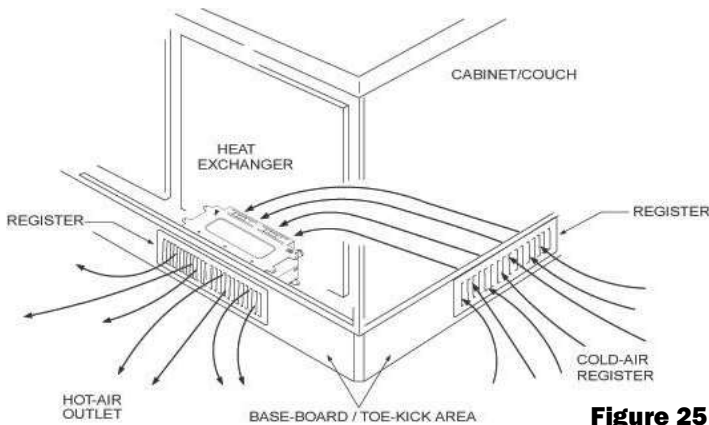

Figure 25

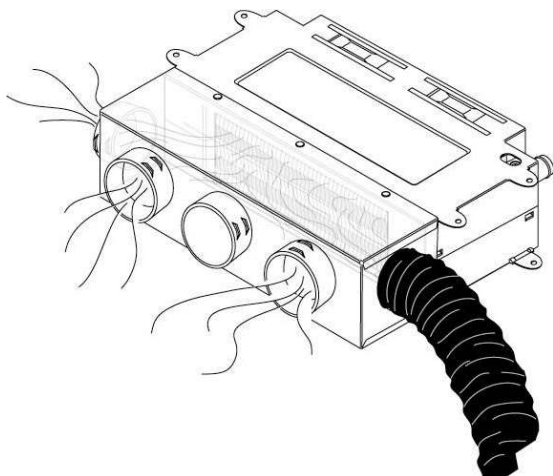

Figure 26

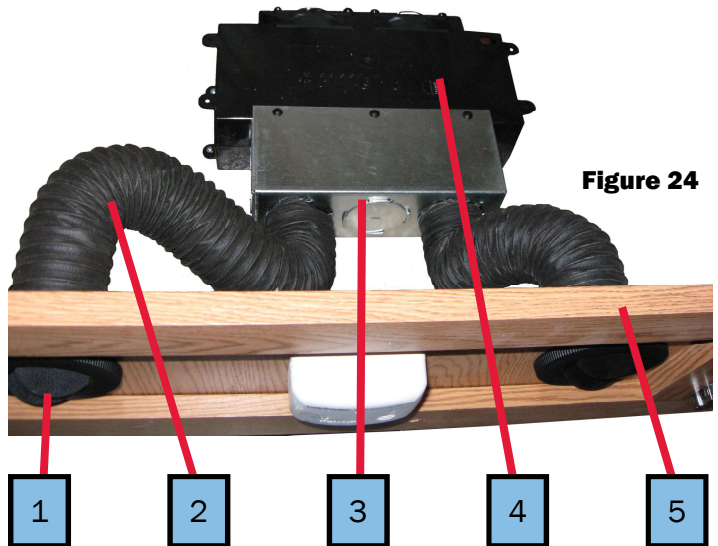

Figure 24

1. Hot Air Outlet Vent
2. Air Ducting Hose
3. Plenum
4. Cozy Heat Exchanger
5. Toe Kick Board

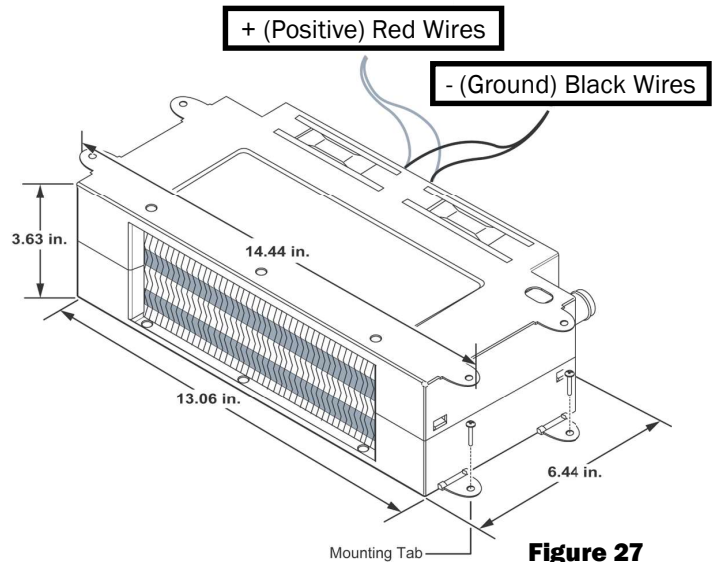

Figure 27

NOTE: When wiring the heat exchangers in parallel, the main 18-gauge wire is split to allow the heat exchanger wires to combine with the main wire to be powered or grounded, respectively.

Wiring the Heat Exchangers

This section will explain in detail how to wire the heat exchangers for optimal functionality. Do not deviate from these guidelines. If a deviation is required, contact Aqua-Hot Heating Systems prior to installing these exchangers for express permission to proceed with modifications.

1. Wire each heat exchanger (in a heating zone) in parallel to one another as shown in Figure 30.
2. Wire each heat exchanger independently to the J7 plug of the Reporter.
3. Pin-out information is shown below.

NOTE: Night-mode functionality of the new controller requires that the heat exchangers be wired directly into the controller.

J7 Wire insertion view shown

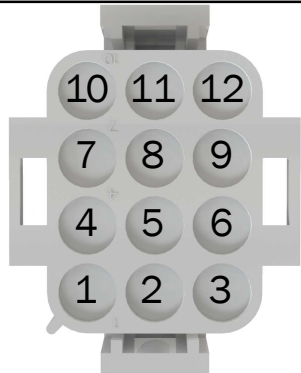

Figure 28

J7 Socket Terminal

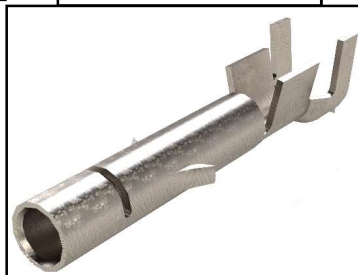

Figure 29

Zone Fan Number	Supply (+) Pin Number	Ground (-) Pin Number
1	J7-12	J7-9
2	J7-2	J7-5
3	J7-11	J7-8
4	J7-1	J7-4
5	J7-10	J7-7

Connector Part Numbers

Part Number	Manufacturer	Description
1-480706-0	TE Connectivity	J7 Plug Housing
350550-1	TE Connectivity	J7 Socket Terminal

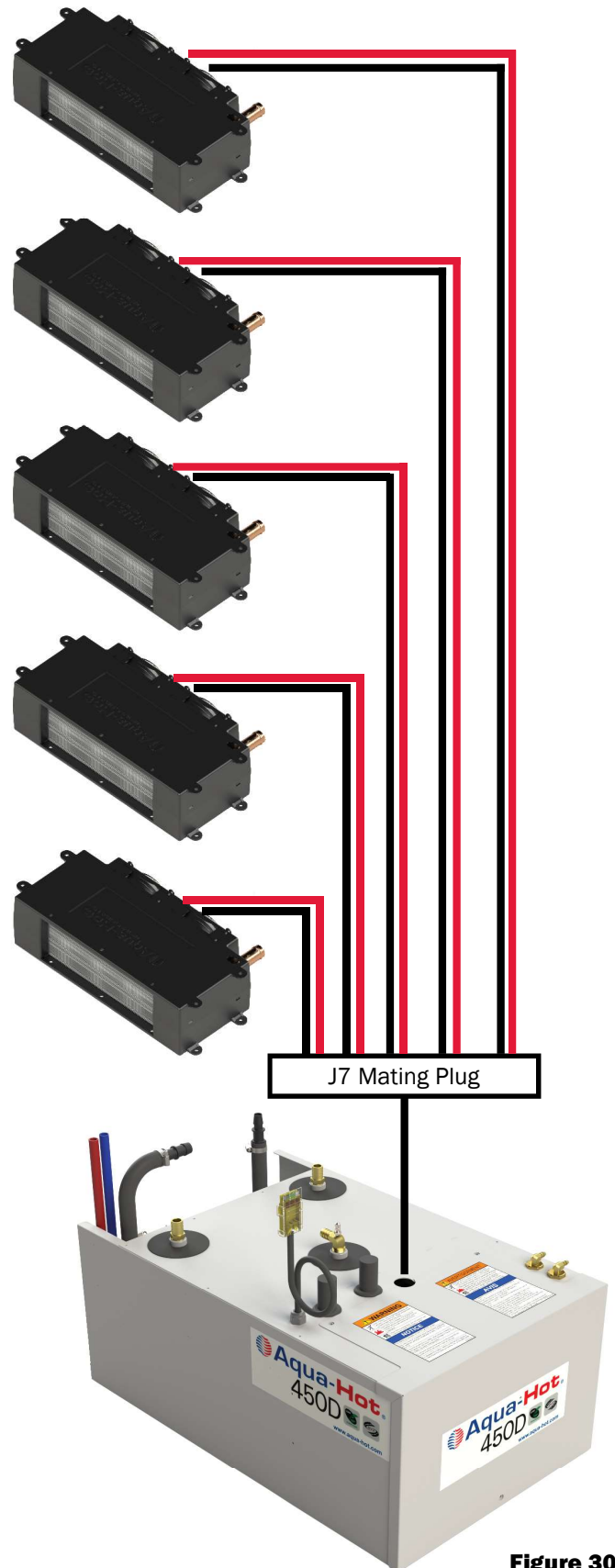

Figure 30

Plumbing the Heating Loop

Once all heat exchangers have been mounted, plan the routing of the plumbing lines from each heating zone to the Aqua-Hot. The following guidelines should be used when planning the coolant loop(s) for the heating zone. The order of the heat exchangers should consider priority on the loop(s). Failure to adhere to these installation principles can hinder the operation of the heat exchangers.

- All plumbing should be installed as flatly as possible.
- Extreme rises in height should be avoided to avoid any potential air traps.
- Use 5/8" ID (Inside Diameter) plumbing lines, 3/4" SAE J20 type coolant hose, heater hose, or PEX tubing for the heating loop(s).
- Use wide-sweeping elbows or "bend supports" whenever the plumbing lines may be susceptible to kinking.
- Plumbing lines should be run in areas where there is no reasonable possibility that they can be pinched off or damaged under normal operating conditions.
- Secure all lines where necessary and apply protective shielding in areas where chafing may occur.
- Rubber coated/closed-type clamps are recommended when securing the plumbing lines.
- Inlet and outlet plumbing lines can be installed with a straight fitting or an elbow.
- See Figure 32 for reference.

Instructions:

1. Layout the plumbing lines for all heat exchangers.
2. Label each line with the heating loop number and designate as an outlet or an inlet line.
3. Connect and clamp the outlet line from the heater to the lowest port (inlet port) with the longest run for both heating loops.
4. Connect and clamp a line from the first heat exchanger's highest port, and connect the other end to the next heat exchanger's lowest point.
5. Connect each additional heat exchanger in the same arrangement.
6. Connect and clamp the inlet line from the heater to the highest port on the last heat exchanger to complete the heating loop.

NOTE: Plumbing heat exchangers in this manner will allow air to escape naturally. If air is trapped in any heat exchanger, it will significantly reduce the exchanger's overall heating performance.

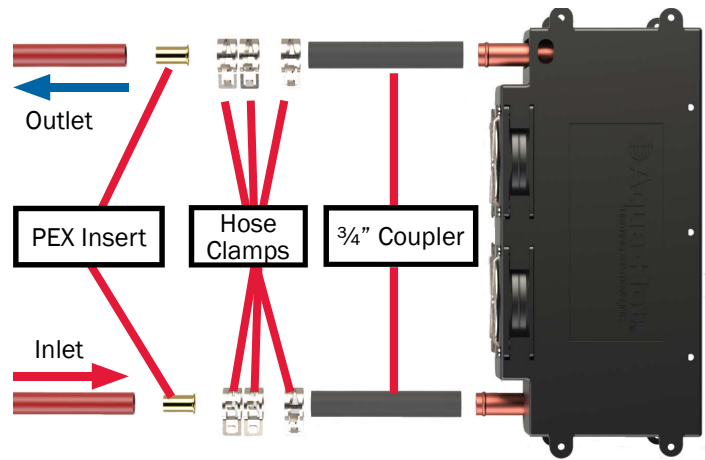

Figure 31

NOTE: The kitchen and living room heat exchangers must be plumbed together **in-series** on "Heating Loop 1". The fresh water tank, bedroom, and bathroom heat exchangers must be plumbed together **in-series** on "Heating Loop 2". See the diagram below.

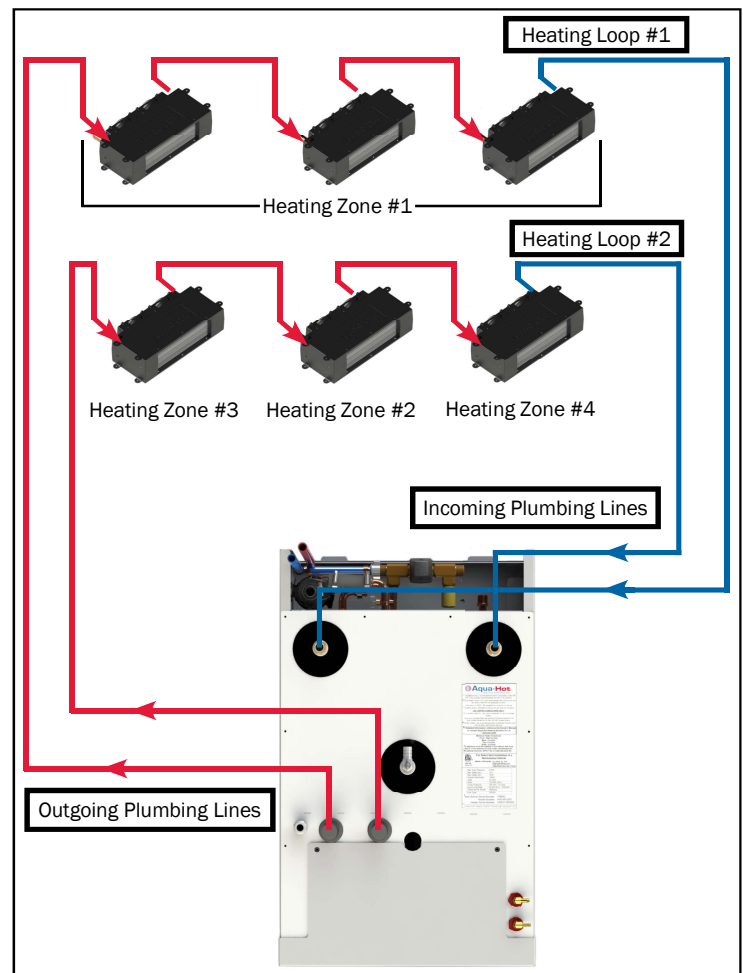

Figure 32

Barbed Fittings Components

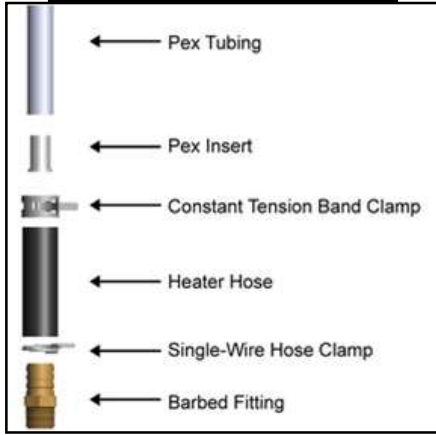

Figure 33

Compression Fittings Components

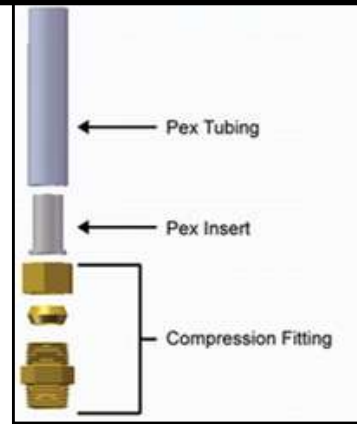

Figure 34

Barbed Fittings Components Installed

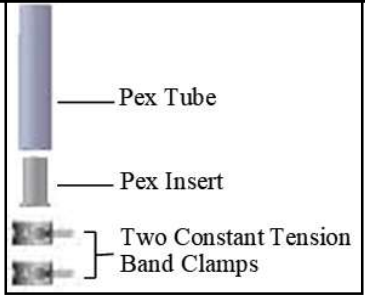

Figure 35

Compression Fittings Components Installed

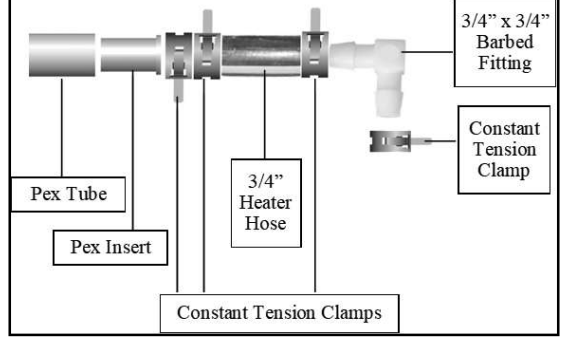

Figure 36

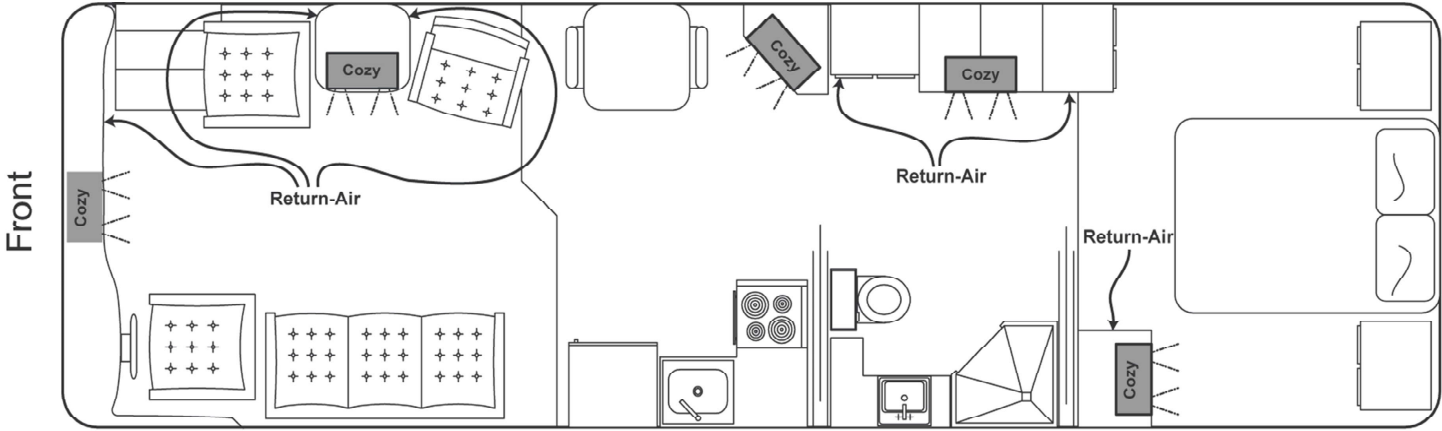

Figure 37

NOTE: This is just a sample for mounting locations of the Cozy heat exchangers. Actual placement and quantity may vary on the individual design of the RV. For questions or assistance, contact Aqua-Hot at 574-AIR-XCEL (574-247-9235).

NOTE: For the best performance, the first heat exchanger should be placed where heat loss is the greatest. The first heat exchanger will always output the largest volume of heat as compared to subsequent exchangers.

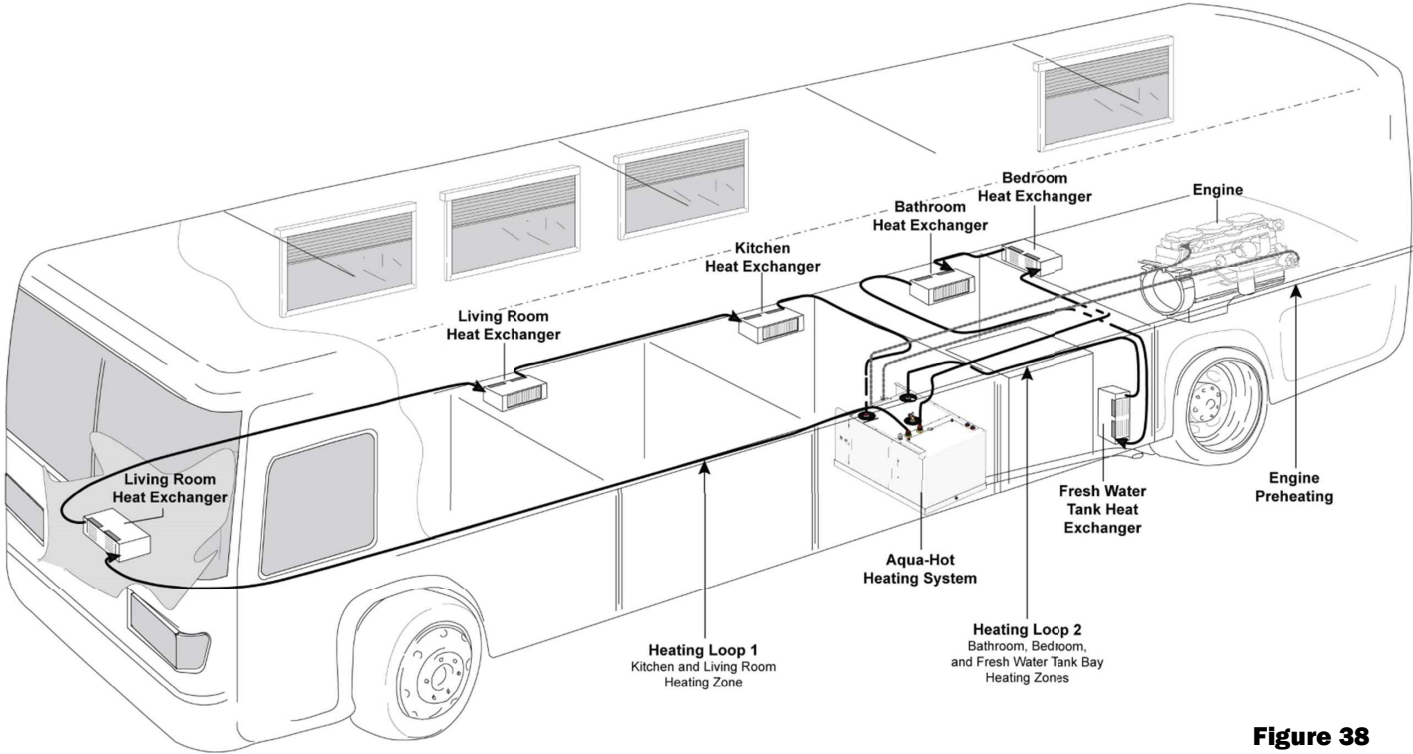

Figure 38

Engine Preheat & Motor-aide System

The Aqua-Hot 450D includes a motor-aide feature that uses the circulation of the motor home's engine to transport the antifreeze and water heating solution from the Aqua-Hot's boiler tank to the motor home's warm engine and back to the boiler tank. The 450D also includes an engine preheat feature that provides an easy engine start-up whenever colder weather conditions are present.

Engine Preheat Location

- The inlet and outlet ports on the vehicle's engine should be kept as far apart as possible. This will ensure that the entire engine is thoroughly preheated. See Figure 39.

NOTE: If assistance is needed in determining the best inlet and outlet ports for a specific engine, please contact the particular engine's manufacturer or chassis supplier.

- The engine's coolant should be allowed to flow as freely as possible to maximize the Aqua-Hot's engine preheating system.
- The engine's inlet port is where the heated coolant is transported to the engine block from the Aqua-Hot. This port should be a high connection point on the engine block. Refer to Figure 39.
- The engine's outlet port is where the engine's coolant is transported to the Aqua-Hot. This port should be a low connection point on the engine block or a pressure outlet port on the engine's water pump (Figure 39).
- Ensure that the engine preheat inlet and outlet hoses are not placed too close to the engine's turbocharger.

Plumbing Requirements

- Use 3/4" ID (Inside Diameter) plumbing lines, automotive-type heater hose for the engine preheating system.
- Lay both engine preheat lines as flat as possible and avoid any extreme rises in height in order to eliminate the potential for air traps.
- Run both plumbing lines in areas where they cannot be pinched off or damaged during normal operating conditions.

NOTE: Rubber coated, closed-type clamps are recommended when securing the plumbing lines.

- Use one-piece engine plumbing fittings in order to reduce the potential for coolant leaks. It is recommended that pipe thread sealant be used on all engine plumbing.

Plumbing Installation

1. Install both engine preheat plumbing lines and mark with arrows and/or labels at both ends.

NOTE: The labels should indicate whether the plumbing line is transporting coolant to the Aqua-Hot, or if it will be transporting heated coolant to the vehicle's engine. Reference Figure 39.

2. Drain the engine's coolant.
3. Remove the selected inlet and outlet port "plugs" from the engine.

NOTE: Should one or both of the selected engine ports already have plumbing fittings attached, it may be necessary to "tee" into those existing plumbing fittings. Please contact Aqua-Hot Heating Systems at +1 (800) 685-4298 for additional assistance.

4. Install and tighten the plumbing fittings into the inlet and outlet ports on the vehicle's engine.
5. Install and clamp both the inlet and outlet engine plumbing lines, automotive-type heater hoses to the engine's plumbing fittings. Reference Figure 39.
6. Install and tighten a plumbing fitting into the "inlet" port on the Aqua-Hot's engine preheating system. See Figure 40.
7. Attach and clamp the engine's incoming plumbing line to the Aqua-Hot's outlet connection.
8. Attach and clamp the engine's outgoing plumbing line to the Aqua-Hot's inlet connection.
9. Verify all fittings and connections have been tightened, then refill the engine's coolant system.

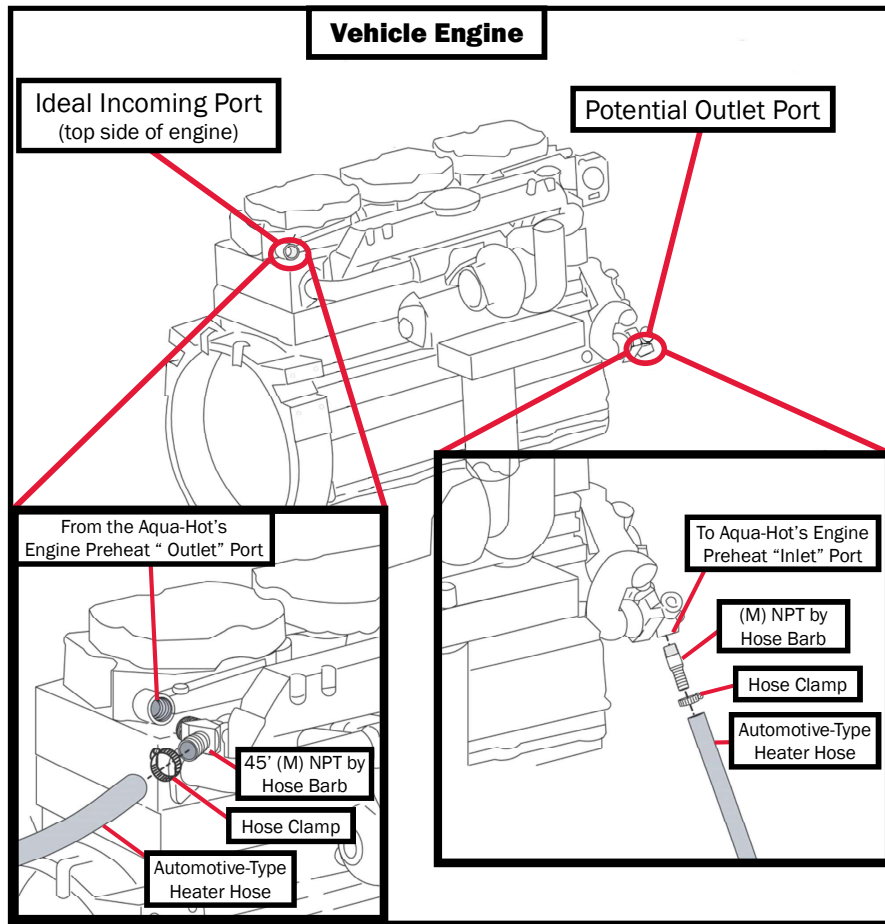

Figure 39

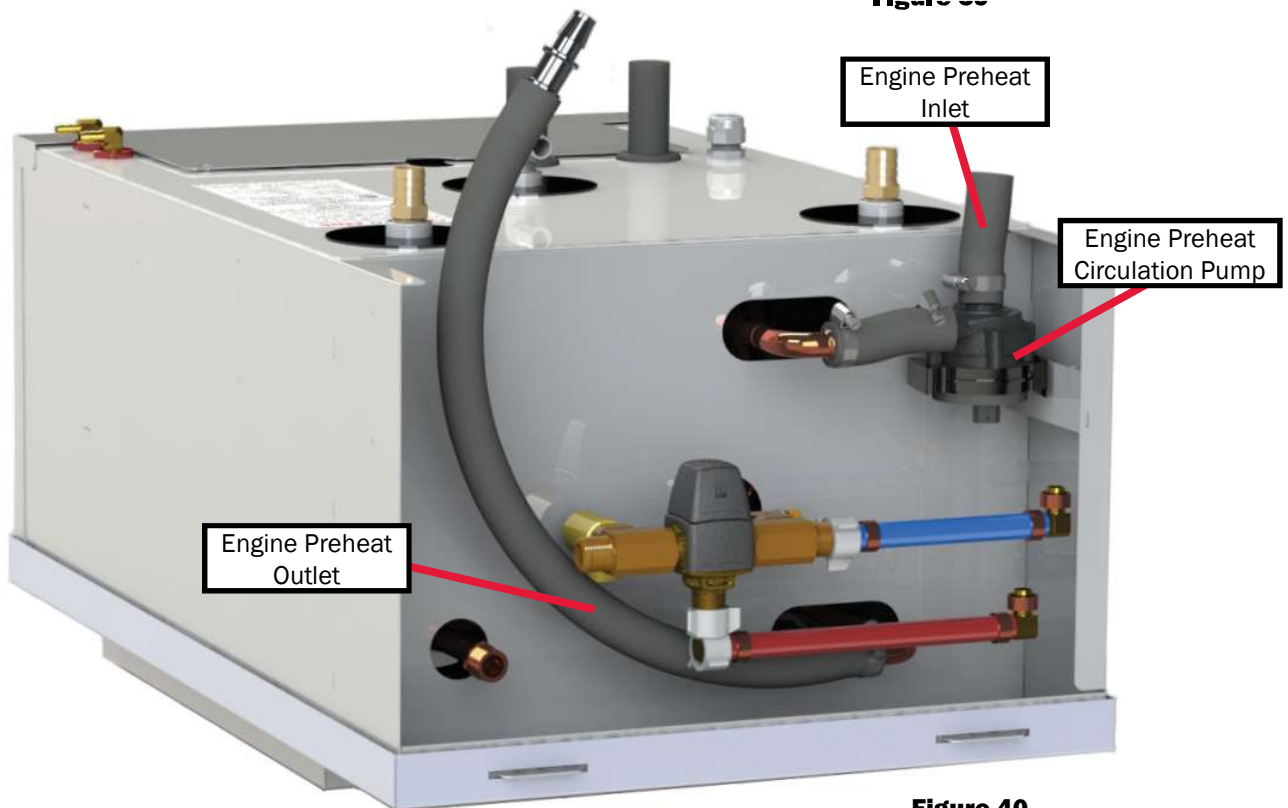

Figure 40

Diesel Fuel System

The following section outlines the requirements for diesel fuel delivery to the Aqua-Hot unit. Read and adhere to all of the outlined requirements to ensure best, and safest performance of the Aqua-Hot.

A kinked fuel line (return side) will increase the fuel pressure to hazardous levels and may cause a fuel line to rupture. A kinked fuel line could also severely damage the diesel burner's internal fuel system.

Fuel Filter Location

- Mount the fuel filter assembly in a location that provides easy access for replacing the filter and for catching any potential fuel spillage when servicing.

Fuel System Requirements

- The diesel fuel supply should be drawn directly from the vehicle's main fuel tank or from a separate auxiliary fuel tank, if applicable.
- The fuel tank should be equipped with a dedicated fuel pick-up pipe (outlet and inlet port). Reference Figure 41.

NOTE: If an auxiliary fuel tank is required, be sure to consult the ANSI/NFPA 1192 Handbook concerning heating system's diesel fuel system specifications.

- Use ¼" ID (Inside Diameter) fuel lines.
- The combined length of the supply and return fuel lines should not exceed 100 feet in total length. Reference Figures 42 & 43.
- All fuel-fitting hardware (at the vehicle's fuel tank: fuel filter and Aqua-Hot fuel parts) must be ¼" NPT or greater with a ¼" barbed fitting. Fuel fittings less than ¼" NPT may restrict fuel flow, thereby compromising the diesel burner's performance.

Fuel System Installation

- Both fuel lines (supply and return) should be laid as flat as possible and any extreme rises in height should be avoided in order to eliminate any potential air traps.
 - Run both fuel lines in areas where they cannot be pinched, kinked, or damaged during normal operation.
 - Run the fuel tank outlet fuel line past the fuel filter location in preparation for Step 7.
1. Run two ¼" fuel lines from the fuel tank inlet and outlet ports to the Aqua-Hot.
 2. Be sure to secure all fuel lines where necessary and apply protective shielding in areas where chafing may occur.
 3. Label both fuel lines indicating whether they are an outgoing line or incoming line.
 4. Connect the Aqua-Hot's fuel lines to the vehicle's fuel tank.
 5. Install and tighten the appropriate fuel fittings onto the Aqua-Hot's fuel ports, as well as the two ports of the fuel filter. Reference Figure 44 & 45.
 6. Connect the inlet and outlet fuel lines to the Aqua-Hot's fuel port connections.
 7. Cut the fuel line at the fuel filter mounting location and connect the fuel lines as illustrated in Figure 44.

NOTE: Be sure the flow of fuel through the filter is in the correct direction.

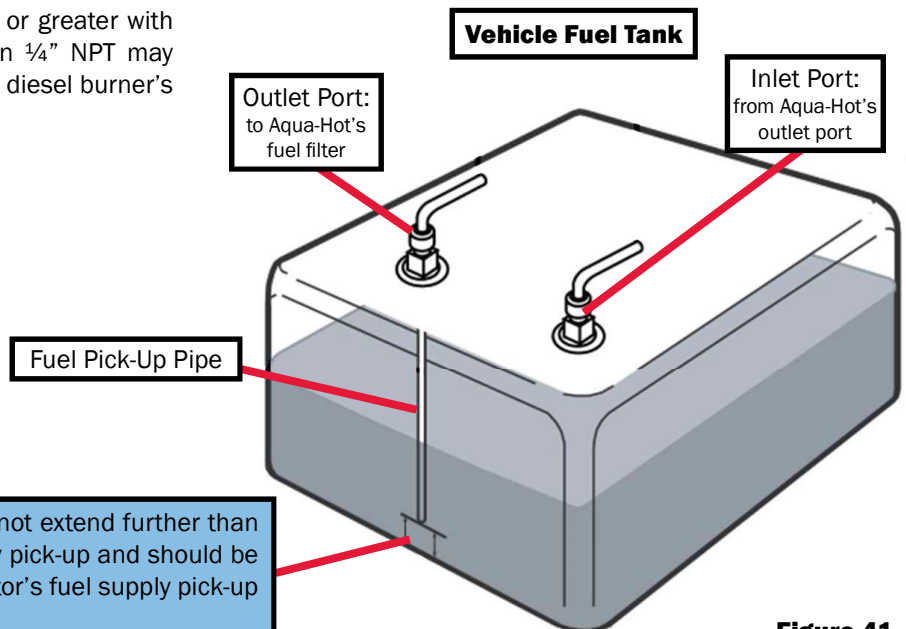

NOTE: The fuel pick-up pipe should not extend further than the motor home's engine fuel supply pick-up and should be consistent with the on-board generator's fuel supply pick-up length.

Figure 41

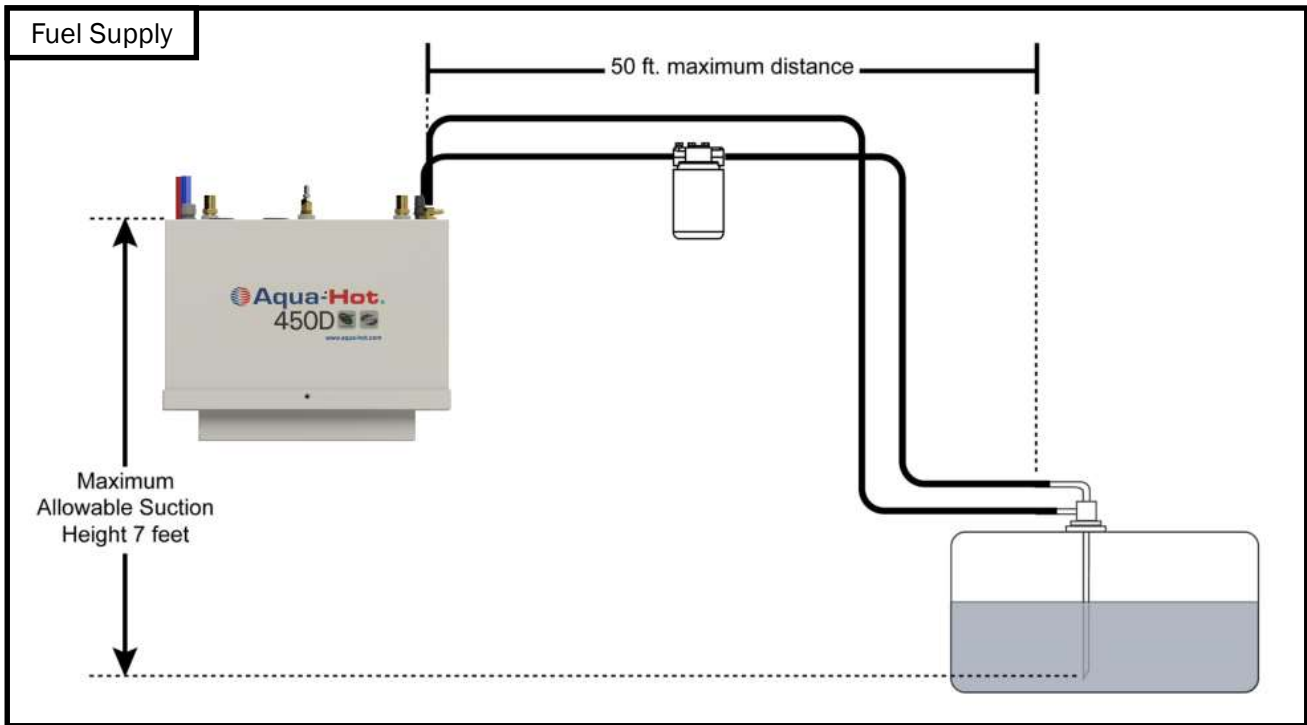

Figure 42

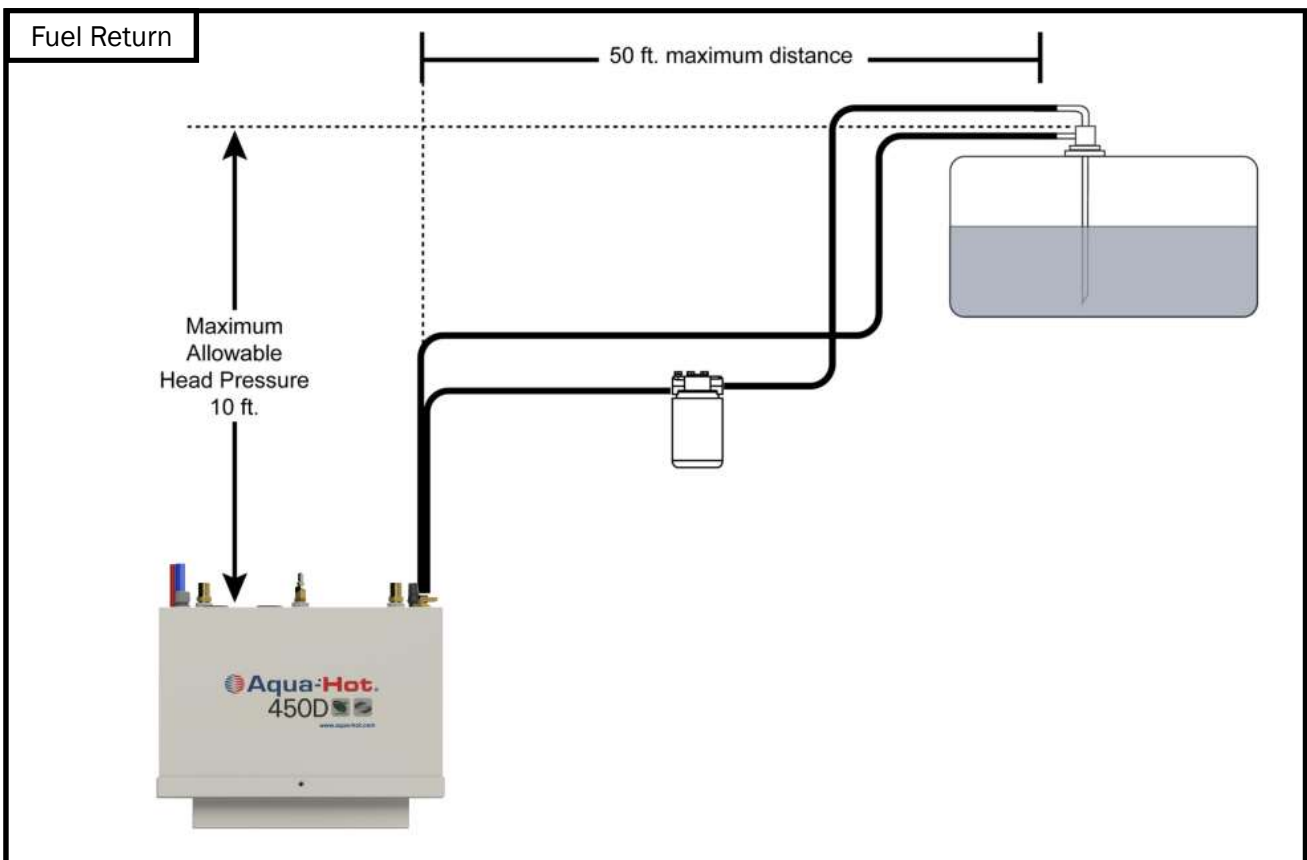

Figure 43

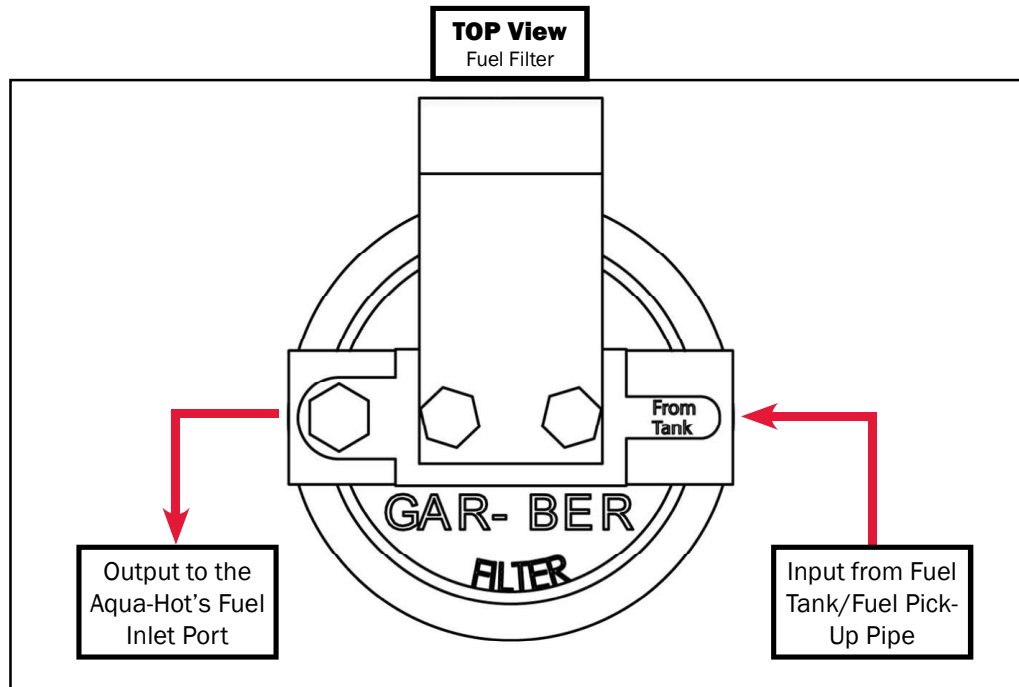

Figure 44

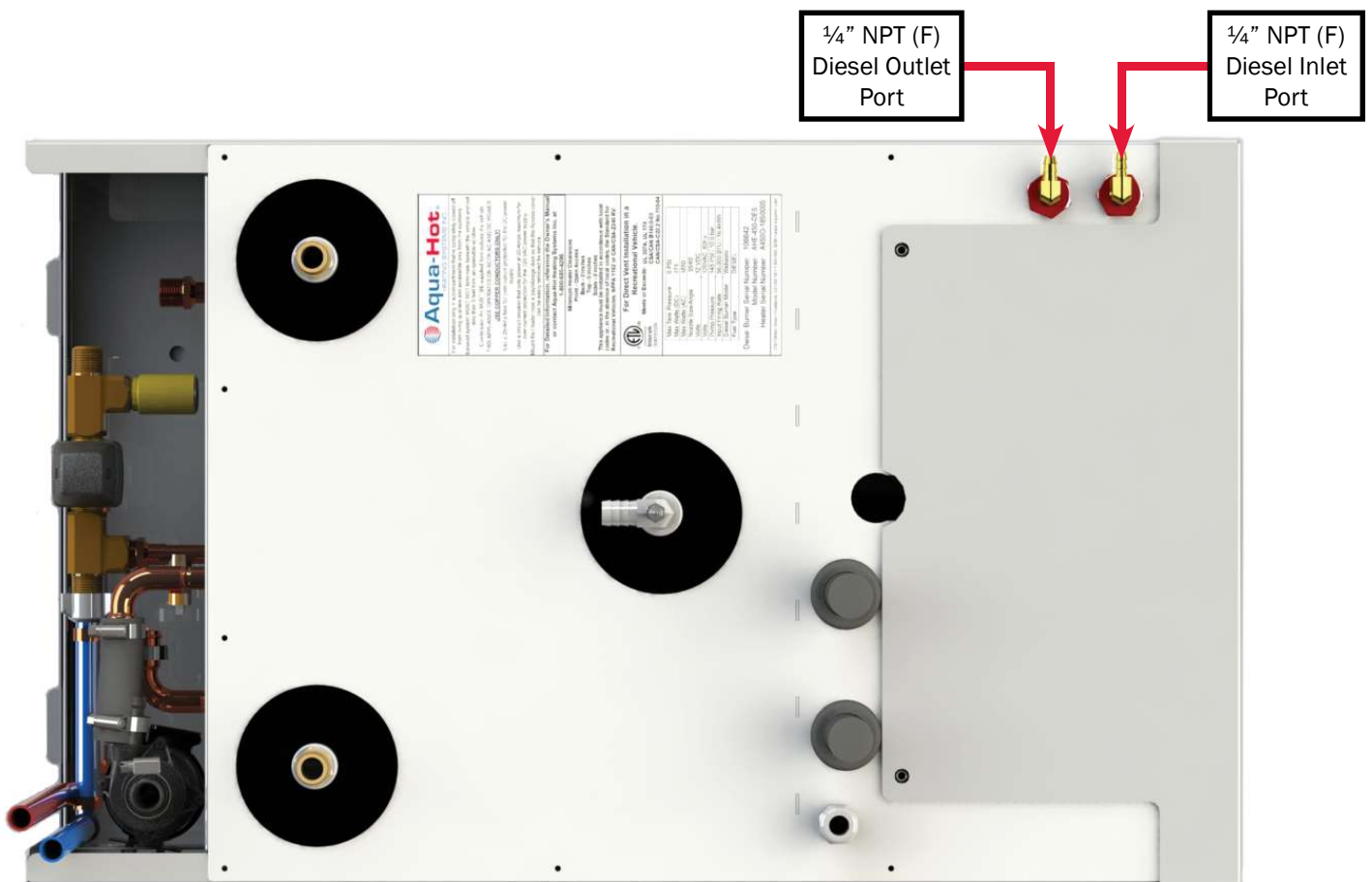

Figure 45

Domestic Water System Requirements

- Reference A119.2/NFPA 501C Standard on Recreational Vehicles 1993 Edition for relevant regulatory information regarding the design of Domestic Water Systems.
- The Aqua-Hot is equipped with a pressure relief valve and a tempering valve in order to provide safe hot water without chance of scalding or an over-pressurized system.
- Plumb the domestic water system according to Figure 47.

Use the RVIA provided table below in order to determine the proper sizing of pipe and tubing required to ensure maximum efficiency. The size of the water supply piping and branch line shall not be less than specified in the table below.

Please note it may be necessary to utilize an accumulator tank within the domestic water system. Reference Figure 47. Although the 450D is equipped with a pressure relief valve, the use of an accumulator tank will help prevent excessive “weeping” of the valve. Manufactured pressure relief valves will cause the “seat” in the valve to deteriorate, which can cause the valve to fail permanently. Be sure to reference the RVIA’s (Recreational Vehicle Industry Association) technical publication titled “Recreational Vehicle Plumbing Systems”. To obtain a copy of this publication, contact RIVE at (730) 620-6003 or visit them online at www.rvia.org.

NOTE: Extended exposure to household bleach will corrode the components of the Aqua-Hot that will potentially dramatically shorten the operational lifetime of the Aqua-Hot. Under no circumstances is the Aqua-Hot to be exposed to household bleach for extended periods of time. This type of damage is not covered by the Aqua-Hot warranty.

NOTE: As stated directly from the ANSI A119.2/NFPA 501C Standards on Recreation Vehicles, 1993 Edition:
“Piping Systems shall be sized to provide an adequate quantity of water to each Plumbing Fixture at a flow rate sufficient to keep the Fixture in a clean and sanitary condition without any danger of back-flow or siphoning”.

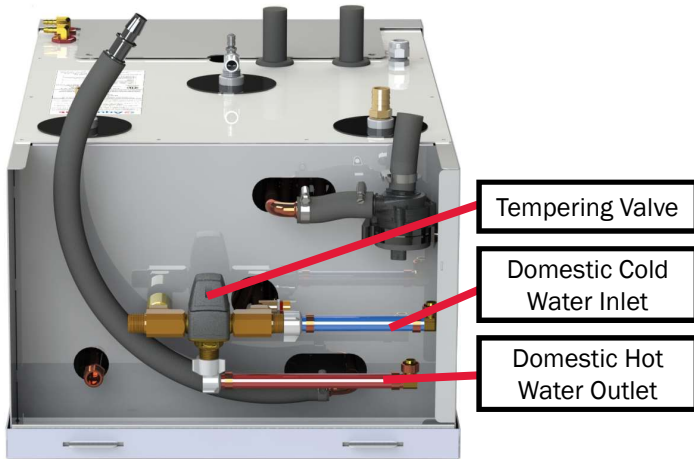

Figure 46

WATER SUPPLY PIPE SIZES

Number of Fixtures	Tubing		Pipe
	Inner Dia. (inches)	Outer Dia. (inches)	Iron Pipe Size (inches)
1	1/4**	3/8**	3/8
2	1/4***	3/8***	3/8
3	3/8	1/2	1/2
4	3/8	1/2	1/2
5 or more	1/2	5/8	1/2

* Minimum size for toilet water supply line shall not be less than the size recommended by the toilet manufacturer.

** 12-feet (3.7 m) maximum length allowable only from water service connection to a single fixture.

*** 6-feet (1.8 m) maximum length.

Plumbing the Domestic Water System

The Aqua-Hot is also able to provide domestic hot water while the boiler tank is up at operating temperature. Activate the Diesel burner to provide adequate heat for hot water needs. The electric element will provide light duty hot water.

The tempering valve is integrated into the cabinet of the Aqua-Hot, and is set upon departure from the Aqua-Hot factory. So long as the tempering valve is not modified, it will provide hot, non-scalding water. The Aqua-Hot is required to have a pressure relief valve that releases excessive pressure in the domestic water system.

Instructions

1. Connect a domestic water plumbing line from the domestic water demand pump to the cold water inlet port (blue PEX) on the Aqua-Hot.
2. Connect a domestic water plumbing line from the Aqua-Hot's hot water outlet port (red PEX) to the hot water system's distribution lines.

⚠ DANGER



Risk of Severe Burn or Death from Scalds. Water temperature over 51°C (123.8°F) can cause severe burns instantly or death from scalds. See instruction manual before setting temperature at water heater. Feel water before bathing or showering. Temperature limiting valves are available, see manual.

WARNING:
 HOT WATER CAN PRODUCE 3RD DEGREE BURNS
 - IN 6s AT 60°C (140°F)
 - IN 30s AT 54°C (129.2°F)
 WATER DELIVERY TEMPERATURE MIXING VALVE WAS FACTORY SET AT 49°C (120.2°F).
 CONTACT QUALIFIED SERVICE PERSONNEL FOR ADJUSTMENTS.

Risque de brûlures graves ou la mort de brûlures. De l'eau à une température au-dessus de 51 °C (125 °F) peut ébouillanter et causer instantanément des brûlures graves allant jusqu'à la mort. Consultez le manuel d'instruction avant de régler la température du chauffe-eau. Vérifiez la température de l'eau avant de prendre un bain ou une douche. Des soupapes de limite de température sont disponibles. Voir le manuel.

AVERTISSEMENT:
 L'EAU CHAUDE PEUT PRODUIRE DES BRÛLURES DE TROISIÈME DEGRÉ
 - EN 6s À 60 °C (140 °F)
 - EN 30s À 54 °C (129.2 °F)
 LA VANNE DE MÉLANGE DE TEMPÉRATURE D'ALIMENTATION EN EAU A ÉTÉ RÉGLÉE EN USINE À 49 °C (120.2 °F). CONTACTER DU PERSONNEL DE SERVICE QUALIFIÉ POUR LES AJUSTEMENTS.

LDE-003-260

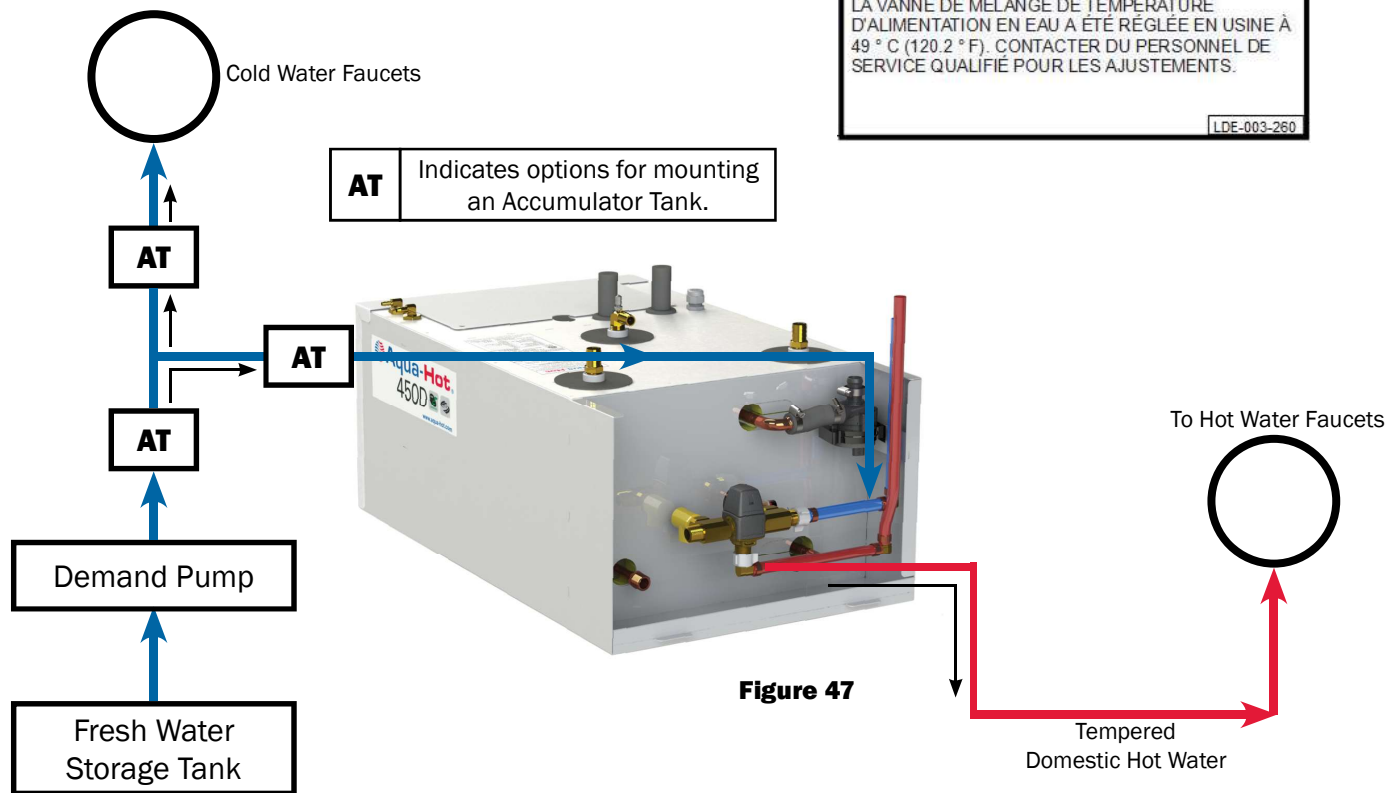

Fresh Water Tank Thermostat

Select a location that will ensure even heat distribution throughout the fresh water storage bay compartment in order to prevent the domestic water and plumbing system from freezing.

Typically, only the bulb of the thermostat needs to be physically mounted in the area requiring heat (usually in close proximity to the domestic water pump). Reference Figure 49.

- Do not mount the thermostat bulb in a drafty area or along the ceiling of the bay.
- The selected mounting location should allow for easy access and should be as low in the bay area as possible.
- Avoid mounting the fresh water tank thermostat's bulb too close to the bay heat exchanger.
- Aqua-Hot recommends using Heating Zone 4 for the Bay thermostat, as Zone Circulation Pump 2 is for Zone 4. However, you can wire to which ever zone of your preference.

Fresh Water Tank Thermostat Mounting

1. Select a location for the thermostat bulb in the fresh water storage tank bay compartment.
2. Once the thermostat has been completely wired, permanently mount the thermostat in place.

Fresh Water Tank Thermostat Wiring

1. Run two 18-gauge wires from the thermostat's mounting location to the Aqua-Hot's Reporter J1 & J9 Pin.
2. Insert the positive wire (#82) to the J9-5 Pin on the Reporter, and insert the ground wire (#83) to J1-8 Pin.
3. Connect both wires to the appropriate leads of the thermostat.

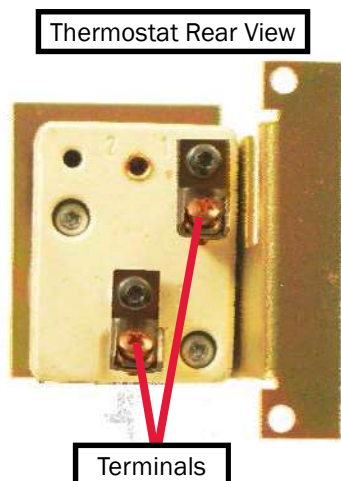

Figure 48

Room Thermostat Locations

Select a location that will ensure even heat throughout each heating zone. Place each room thermostat at approximately chest level, if applicable.

The selected location should prevent the thermostat from being affected by the following.

- Drafts or dead spots behind doors and in corners.
- Hot or cold air ducts.
- Radiant heat from sun or appliances.
- Heat from concealed pipes and chimneys.
- Unheated or uncooled areas such as an outside wall behind the thermostat.

Room Thermostat Mounting

1. Select a location for the thermostat in the coach.
2. Once the thermostat has been completely wired, permanently mount the thermostat in place. Be sure the thermostats are turned OFF.

Room Thermostat Wiring

1. Run two 18-gauge wires from each room thermostat mounting location to the Aqua-Hot's Reporter J1 & J9 Pins.
2. Insert the positive wire to the J9 Pin on the Reporter, and insert the ground wire to J1 Pin.
3. Connect both wires to the appropriate leads of the thermostat. Reference the wiring schematic on Page 51.

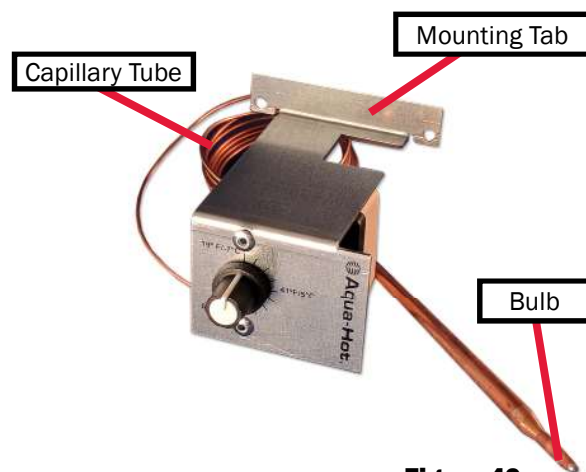

Figure 49

Interior Switch Panel

Select a location in the interior of the coach that allows for easy operator access. The switch panel should be installed in a central location inside the coach that is easily accessible to turn the system on and off. Mounting plate dimensions for the panel are shown below.

Coach Control Panel Screen:

Newer Aqua-Hot units that come equipped with the Reporter may have a coach touch-screen display instead of the interior switch panel. This section is only for the installation and wiring for the interior switch panel.

All electrical installations, systems, and equipment shall comply with Article 551, Parts I through VI of NFPA 70, as well as the regulation of authorities having jurisdiction and CSA Standard B139.

NOTE: Be sure to attach “Jumper Wires” where necessary. Reference the following switch diagrams.

Switch Panel Mounting

1. Cut out a 3.75” W x 1.25” H opening for the switch panel plate. Reference Figure 50.
2. Once the switch panel has been completely wired, permanently mount the switch panel in place.
3. Using four countersunk 3mm (#4) screws, secure the switch plate into place over the cutout just made.

Switch Panel Wiring

1. Run 16-gauge wires from the switch panel to the Reporter.
2. Strip and crimp insulated female terminals onto each wire at the switch panel location.
3. Connect all switch wires to the appropriate switch connections. Reference the following diagrams per the switch model.
4. Insert all switch wires into the appropriate pin connection for the Reporter. Reference the schematic on Page 49.

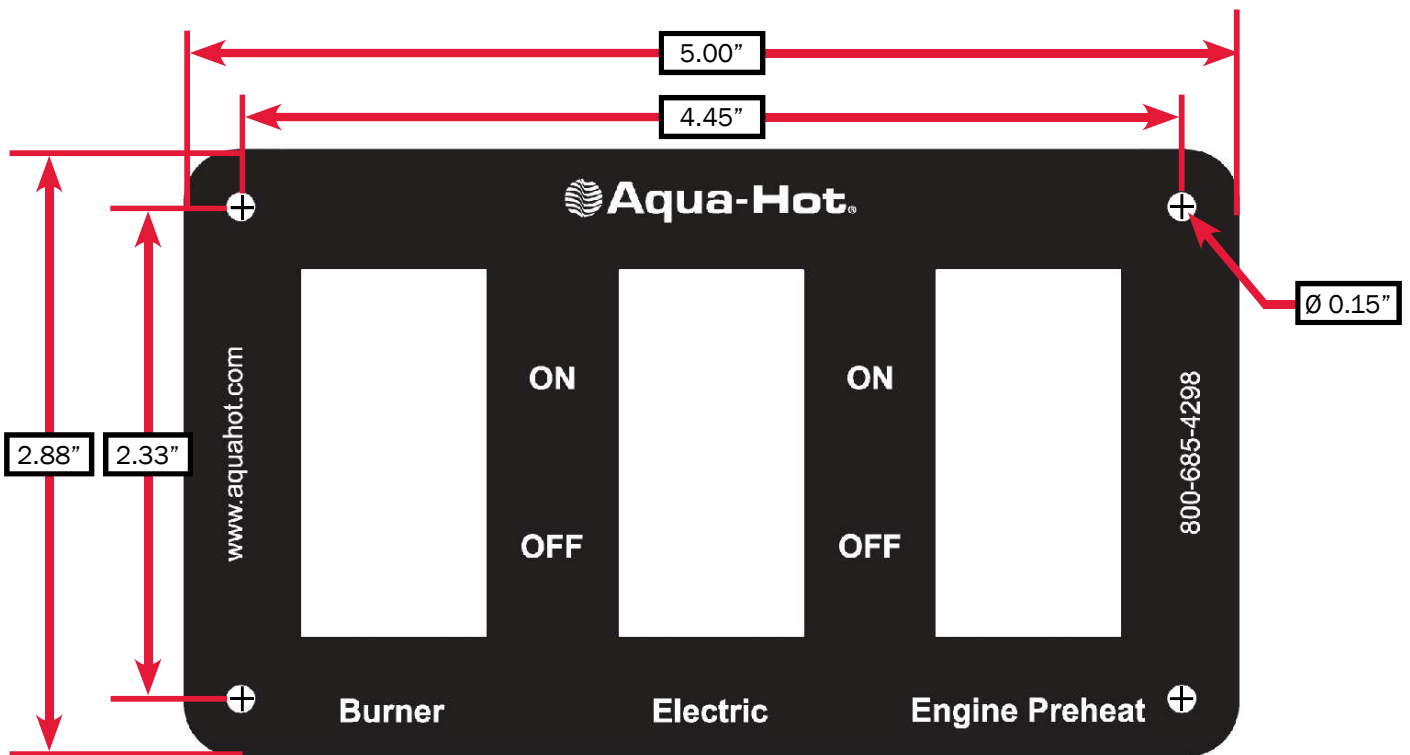
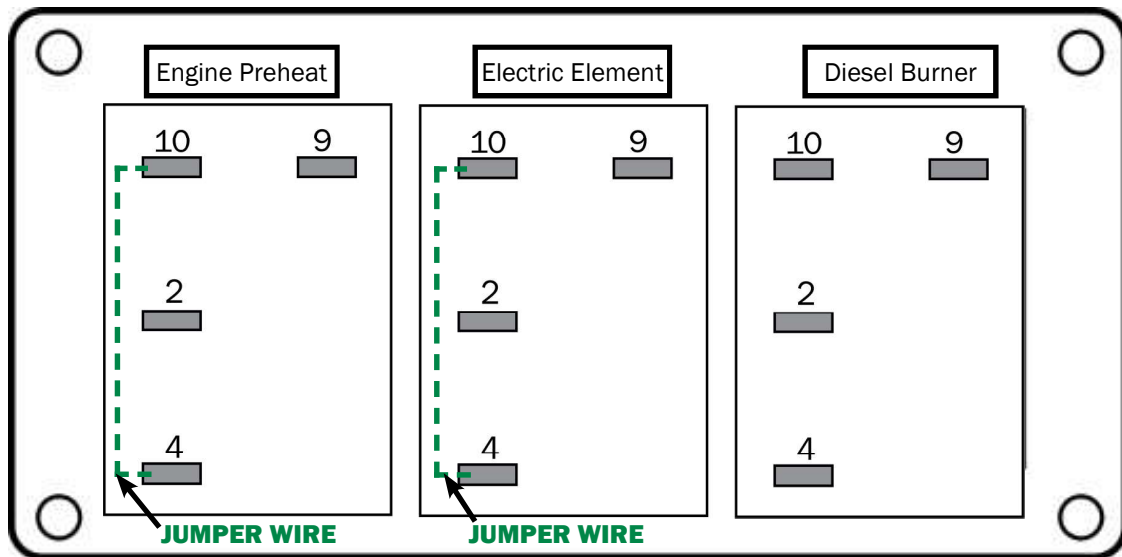

Figure 50



Figure 51

Switches Rear View



Switch Pin	Wire Harness
#2	J9-1
#4	J1-4
#9	Chassis Ground

Switch Pin	Wire Harness
#2	J9-2
#4	J1-2
#9	Chassis Ground

Switch Pin	Wire Harness
#2	J1-1
#4	J9-3
#10	J7-3
#9	Chassis Ground

NOTE: The Engine Preheat and Electric Element switches possess jumper wires that advance from terminal 4 to terminal 10.

Wiring the Aqua-Hot

NOTE: Reference the Schematics starting on Page 46 for more information.

This section will introduce the basic considerations, practices, and information necessary to wire the Aqua-Hot to any relevant coach-side systems.



WARNING

Installation must be performed by a professional installer or technician as per national/local regulations.

Improper installation can cause property damage, injury, or death.

J8 Plug:

The J8 plug is responsible for connections that pertain to sensor monitoring within the coach, and is standardized across all Reporter-bearing Aqua-Hot heating systems.

J8 Wire Insertion View Shown

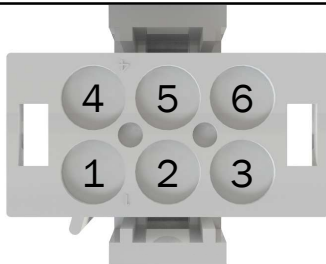

Figure 52

Pin Number	Description	Wire No.
J8-1	Low-Level Sensor Input	16
J8-2	Low-Temp Sensor Input	10
J8-3	Tank Temp Sensor/Control Thermostat	14
J8-4	Low-Level Power Supply (12V DC+)	15
J8-5	Low-Temp Power Supply (12V DC+)	9
J8-6	Tank Temp Sensor/Control Thermostat	13

J1 Plug:

The J1 plug manages heating zone inputs from the coach.

Heating Zone 1 is reserved electrically for the “Living Room - Kitchen Heating Zone” (Heating Loop 1) ONLY. Heating zones 2, 3, & 4 are reserved electrically for the “Bathroom, Fresh Water Tank, and Bedroom Heating Zone” (Heating Loop 2) ONLY.

J1 Wire insertion view shown



Figure 53

Heating Zone 5 is reserved for the “Optional Heating Zone” (Heating Loop 1) ONLY.

See pin-out information below.

	Pin Number	Description	Wire No.
	J1-1	Diesel Input	51
	J1-2	Electric Low Input	53
	J1-3	Not Used	-
	J1-4	Engine Preheat Input	55
ZONE 1	J1-5	Zone 1 Input	95
ZONE 2	J1-6	Zone 2 Input	91
ZONE 3	J1-7	Zone 3 Input	87
ZONE 4	J1-8	Zone 4 Input	86
ZONE 5	J1-9	Zone 5 Input (Optional)	79

J7 Plug:

The J7 plug manages zone fans and the burner switch indicator light..

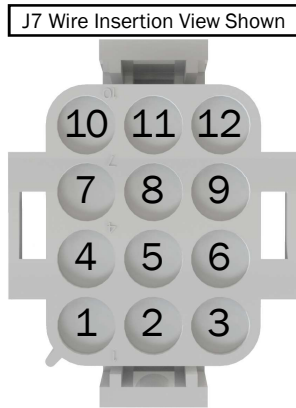

Figure 54

	Pin No.	Description	Wire No.
	J7-6	Burner Indicator Light Ground	57
	J7-3	Burner Indicator Light	56
ZONE 1	J7-12	Zone Fan 1 (Switched 12V+)	92
	J7-9	Zone Fan 1 Ground	93
ZONE 2	J7-2	Zone Zan 2 (Switched 12V+)	88
	J7-5	Zone Fan 2 Ground	77
ZONE 3	J7-11	Zone Zan 3 (Switched 12V+)	84
	J7-8	Zone Fan 3 Ground	85
ZONE 4	J7-1	Zone Zan 4 (Switched 12V+)	80
	J7-4	Zone Fan 4 Ground	81
ZONE 5	J7-10	Zone Fan 5 (Switched 12V+)	76
	J7-7	Zone Fan 5 Ground	78

J9

J9 Wire Insertion View Shown

The J9 plug is an optional use terminal that provides constant 12V DC current to any attachments which may be added to the coach.

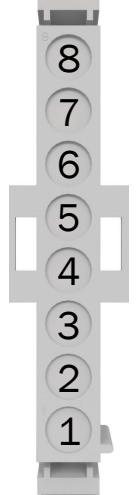

Figure 55

	J9 Pin No.	Description	Wire No.
	J9-1	Engine Preheat	54
	J9-2	Electric	52
	J9-3	Diesel 12V DC Switch	50
ZONE 5	J9-4	Zone 5 Thermostat	78
ZONE 4	J9-5	Zone 4 Thermostat	82
ZONE 3	J9-6	Zone 3 Thermostat	86
ZONE 2	J9-7	Zone 2 Thermostat	90
ZONE 1	J9-8	Zone 1 Thermostat	94

J3

J3 serves as the RV-C connection to the coach-side comfort system (if applicable). The RV-C indicator light located on the back of the Reporter serves as a valuable diagnostic tool when the need to determine RV-C functionality arises.

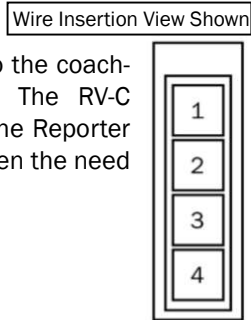

Figure 56

J3 Pin No.	Description
1	12V DC+ Current Out (Optional)
2	CAN-HIGH
3	CAN-LOW
4	Ground

The J3 plug connects to the on-board RV-C system of the coach (if applicable). The RV-C indicator light located on the back of the Reporter serves as a valuable diagnostic tool when the need to determine RV-C functionality arises.

The J3 Plug is a 4-pin connector with self-contained power pins. See the diagram below for the crimping information for the J3 plug. Crimp these parts together using pliers.

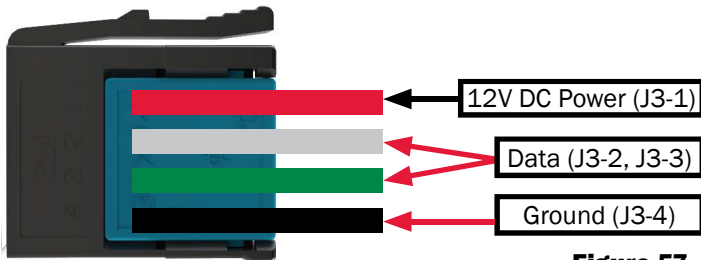

Figure 57

Manufacturer	Part No.	Description
3M	37401-2165-000 FL 100	4-Position Plug (Male)
3M	37104-2165-000 FL 100	4-Position Receptacle Plug (Female)
General Cable	E2104S.41.02	4COND 22AWG WHT SHLD Cable

The parts listed above can be purchased from any major electronics retailer. Only the parts listed above are approved for use in the Aqua-Hot.

J2

The J2 Plug is responsible for managing return signals from within the coach.

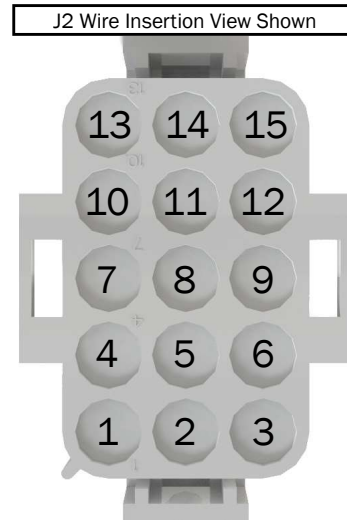

Figure 58

Pin Number	Description	Wire No.
J2-1	Pump 1 Output (12 V DC+)	5A1
J2-2	Pump 1 Ground	6
J2-3	Zone 1 Boost Pump	-
J2-4	Pump 2 Output (12V DC+)	3A
J2-5	Pump 2 Ground	4
J2-6	Power On Signal	24
J2-7	Pump 3 Output (12V DC+)	1
J2-8	Pump 3 Ground	2
J2-9	Zone 2 Boost Pump	39
J2-10	Pump 4 Output (12V DC+)	7
J2-11	Pump 4 Ground	8
J2-12	Electric Element On-Signal	11
J2-13	AC Ground	12
J2-14	Burner Ground	21A
J2-15	Diesel Burner Status Input	19

The Aqua-Hot Reporter



Figure 59

The Aqua-Hot Reporter is a new generation of command and control module that manages all functions of the Aqua-Hot from start-up to shutdown. The previously used electronic control board has been retired on new units in favor of the Reporter.

There are two series of Reporters presently in use: Reporter 1.0 and Reporter 2.0. Reporter 1.0 was launched November 30, 2018, and Reporter 2.0 was launched September 9, 2019.

The launch of Reporter 2.0 allowed an opportunity to improve upon the 1.0 design where ever it was deemed necessary. The Reporter 2.0 features the following design improvements:

- Over-Temperature Fault Functionality
- Precise fluid coolant temperature display
- Boost pumps are now powered directly by the Reporter

Functionality:

The Reporter was designed with a touch-screen interface to simplify and standardize unit use and troubleshooting. Screen navigation and access is now standardized across the Aqua-Hot 450 Series Diesel (DE5 and newer).

The Reporter also contains fault logging functionality, troubleshooting tools, and testing functions. Each of these functions will be explained in detail.

Basic Features:

The Home Screen is the first screen shown on the Reporter. Reporter 1.0 and Reporter 2.0 home screens do differ.

The most substantial difference between the Reporter 1.0 and 2.0 is the inclusion of a thermistor in place of the standard control thermostat. This allows specific Aqua-Hot coolant tank temperatures to be displayed on the Reporter, and relayed to the on-board comfort control systems (if the coach manufacturer installs one). The tank temperature sensor allows more granular control of the Aqua-Hot by switching away from the static temperature limitations imposed by the previous control thermostat.

The Reporter contains a host of diagnostic and troubleshooting tools to more easily repair and operate Aqua-Hot units. These features are organized into pages and sections that are further explained in this guide.

Home Screen

The home screen contains information about the Aqua-Hot system status, as well as model and serial number information.

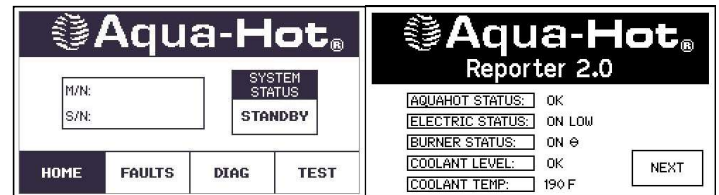

Figure 60

Fault Status

The fault status page contains the last seven faults which were observed by the Reporter, regardless of how much time has passed.

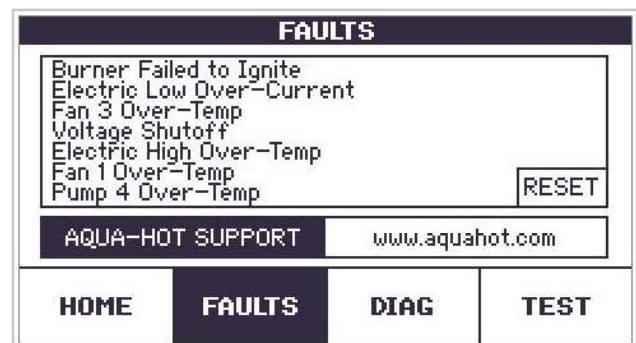

Figure 61

Coach Side I/O

This page of the Reporter will indicate the current status of elements and switches within the coach; such as, the coach is requesting hot water or heat.

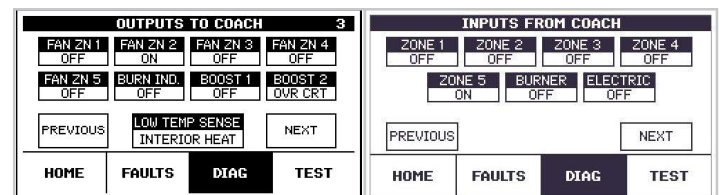

Figure 62

Aqua-Hot I/O

The Aqua-Hot I/O page will show the current status of elements, sensors, and components within the Aqua-Hot itself.

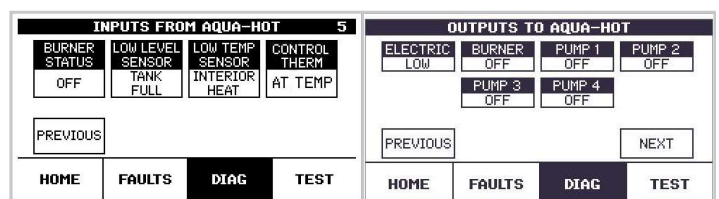

Figure 63

Heat Testing:

The heat testing page of the Reporter will allow the electric and burner heating sub-systems to be independently activated for troubleshooting and testing purposes.

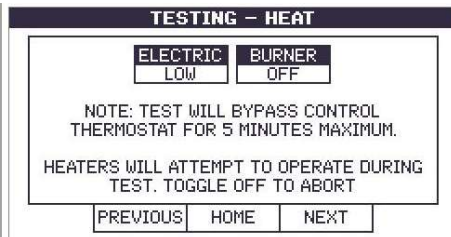

Figure 64

Fan Testing:

The fan testing section of the Reporter will allow the heat exchanger fans within the coach to be activated independently of the rest of the Aqua-Hot.

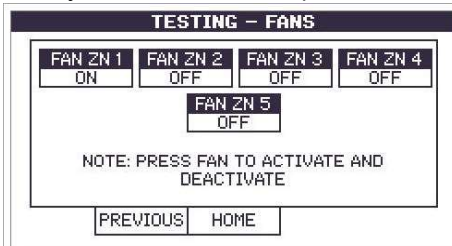

Figure 65

Pump Testing:

The pump testing page of the Reporter functions similarly to the fan testing page in that, from this Reporter page, pumps within the Aqua-Hot can be activated independently from other elements for their functionality to be verified.

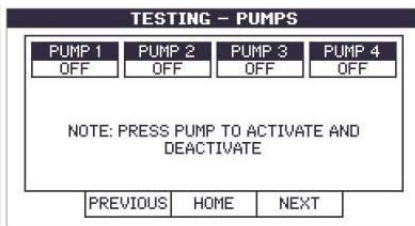

Figure 66

Heartbeat Function

Aqua-Hot Reporter units with at least firmware version 1v5 and all Reporter 2.0 units are equipped with a “heartbeat” function which establishes a signal between the RV-C system and the Reporter.

The Reporter 12V+/- wires are connected directly to the coach battery. The Reporter has an RV-C incorporated house power sense in the event RV-C connection is lost, i.e. house batteries disconnected or RV-C network has failed.

The Reporter will be constantly awaiting a signal from the RV-C network indicating to the Reporter that it is to continue normal operation. Loss of 6 consecutive signals from the RV-C network will trigger the Reporter to deactivate the Aqua-Hot.

This serves as a safety feature to ensure that the Aqua-Hot does not continue to operate if the coach loses power. Once power is restored to the coach and the Reporter unit, “BATTERY DISCONNECT SWITCH OFF” will be displayed in the fault log, indicating that the Reporter has lost connectivity with the RV-C network, and subsequently deactivated.

Technical Information

Mounting:

The Aqua-Hot Reporter can be mounted in two different fashions, either surface mount or recessed mount. Dimensional specifications are shown below. When surface mounting, use a #10 or larger screw. If recessed mounting, use a #6 screw.

There is a slot located at the bottom of the Reporter which serves as access for the harness and power connections. Take these into consideration when choosing the mounting location for the Reporter. Circular dimensions are edge to center.

Aqua-Hot sheet metal cabinets have reference features indented into them for mounting the Reporter to the Aqua-Hot if desired.

NOTE: For networked control of the Reporter, Aqua-Hot requires system integrators ensure that individual commands are received and processed. Aqua-Hot requires that commands be repeated or confirmed so that if a single message were dropped, or if there is a brief network disturbance, the Reporter would get into the correct state as soon as the disruption was removed.

The Aqua-Hot Reporter monitors the heating system and handles all logic relating to safeties and heating control. As such, the system integrator is required to display all pertinent status information but not use that information to lock out operation or add additional safety layers that could impact the end of operation if a message from the Reporter was missed.

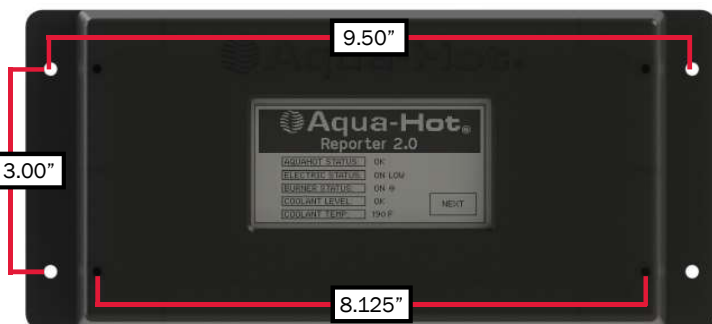

Figure 67

Boost Pumps

Boost pump functionality has changed with the implementation of the Reporter 2.0.

On Reporter 1.0 units, any boost pumps at use within the coach required a relay connected to wires 3b and 5b in order to operate.

With Reporter 2.0, that relay can now be eliminated, with boost pump power and functionality now being handled directly by the Reporter. Using a flag-terminal, connect the boost pump directly to the harness bearing in mind the requirements below.

- Zone 1: Connect to Wire 5b
 - Max Current Draw: 5.0A
 - Over-Current Condition: 8.0A
- Zone 2: Connect to Wire 3b
 - Max Current Draw: 3.0A
 - Over-Current Condition: 5.0A

Original Equipment Manufacturers (OEMs) will need to provide the ground for operating boost pumps from the Reporter.

Electrical Specifications:

The Reporter contains a single Amphenol ATP family connector that serves as the power connection to the coach side 12V DC power system. Mating connection components are not supplied by Aqua-Hot. Compatible part numbers and manufacturers are supplied below. The Reporter must be operated to the below listed specifications.

Minimum Voltage.....	11.0V DC
Maximum Voltage.....	15.0 V DC
Minimum Current.....	75mA
Maximum Current.....	15A

Please note that the minimum current rating is the minimum requirement for what will operate the Reporter. Operating at this current rating will not provide sufficient power to any components dependent upon the Reporter.

Input Load currents

Zone Thermostats (each).....	appx. 1mA
Diesel Burner Switch.....	appx. 1mA
Electric Element Switch.....	appx. 1mA
Low-Level Cutoff Switch.....	appx. 1mA
Control Thermostat (Reporter 1.0).....	appx. 1mA
Tank Temperature Sensor (Reporter 2.0).....	appx. 1mA
Low-Temperature Cutoff Thermostat.....	appx. 1mA

Output Load currents

Zone Fans (Reporter 1.0/all).....	3.0A max
Zone Fan 1 (Reporter 2.0).....	8.0A max
Zone Fans 2-5 (Reporter 2.0).....	5.0A max
Zone Fans (all).....	0.25A max
Circulation Pumps (each).....	2.0A max
AC Relay.....	0.5A max
Burner Power.....	6.0A max

Burner Master Control.....	2.0A max
Burner Thermostat Control.....	1.0A max

Connection Terminal Information

RV-C Mating Connection		
Mfg.	Part Number	Description
3M	37104-A165-00E-MB	RV-C Connection Housing

Reporter Power Connection		
	Deutsche	Amphenol
Pins	1060-12-0222	AT60-12-0222
Housing	DTP04-2P	ATP04-2P
Wedge	WP-2P	AWP-2P

Harness Connections			
Mfg.	Part Number	Description	Mate
TE	1-480706-0	09P UMNL Plug	J1
TE	1-480710-0	15P UMNL Plug	J2
3M	37104-2165-000 FL 100	CONN Plug 2MM 4POS 20-22 AWG	J3
TE	1-480708-0	12P UMNL Plug	J7
TE	1-480704-0	06P UMNL Plug	J8
TE	640582-1	08P UMNL Plug	J9

Sockets			
Mfg.	Part Number	Description	Mate
TE	350550-1	UMNL SOK 20-14 TIN/PHBZ L/P	J1 J2 J3 J7 J8 J0

Socket Crimping Tool		
Mfg.	Part Number	Description
TE	90547-1	ASSY Pro-Crimper M-N-L



Figure 68

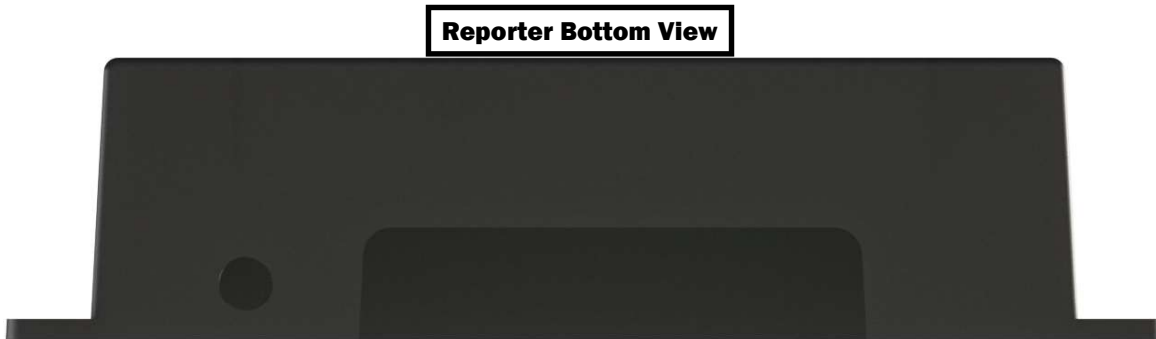

Figure 69

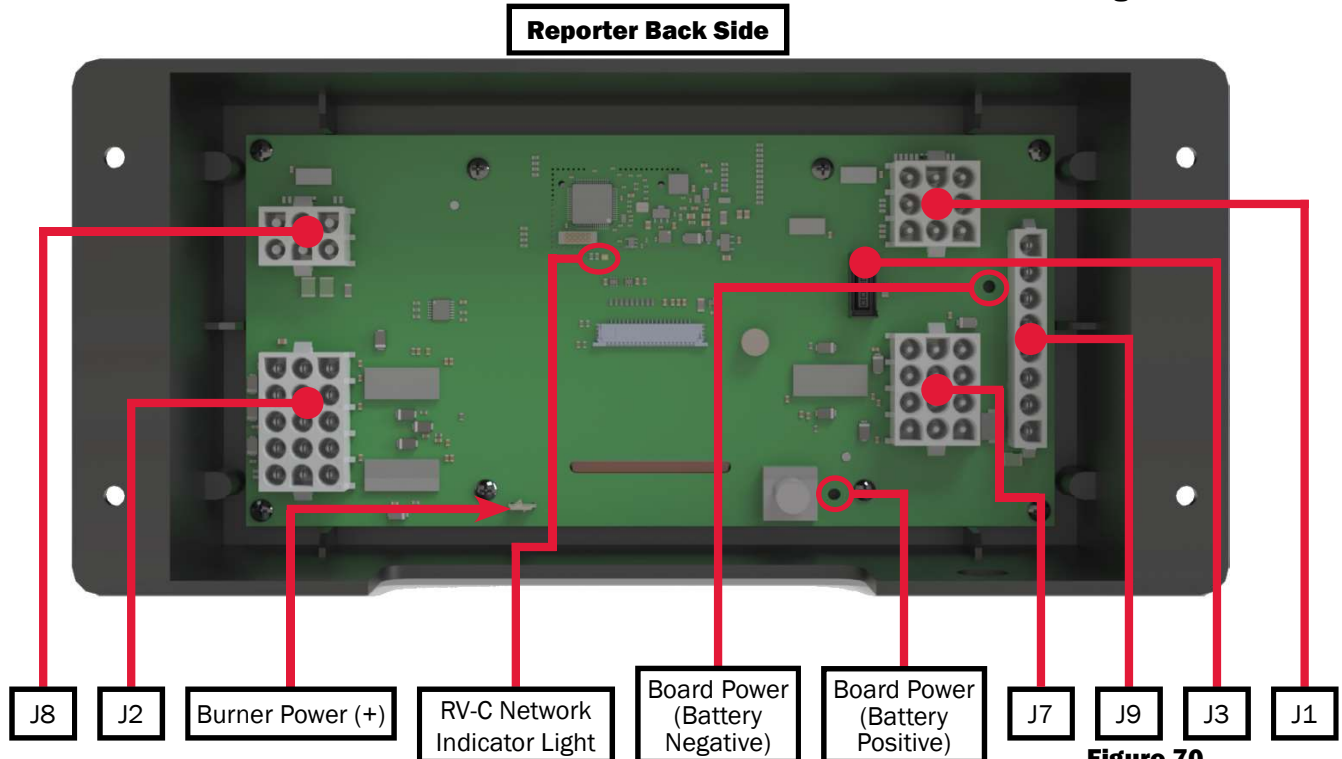

Figure 70

RV-C Network Connectivity

The Reporter was designed to interface with the coach-side RV-C network to aid in the Aqua-Hot's integration into the on-board RV-C network.

There is an indicator light on the back of the Reporter which shows the current status of the Reporter's connection to the RV-C network. This will be useful when diagnosing potential problems with the coach-side RV-C network.

LED Activity		Status
		Solid Green Reporter is connected to network and communicating properly
		OFF Reporter has no power, or has failed completely
		Solid Red Reporter has gone offline and is not connected to network
		Flashing Green (4/second) Reporter is attempting to make an initial connection to the network
		Flashing Green (1/second) The Reporter is online, but it has not received a valid network message for at least 5 seconds
		Alternating Red and Orange Reporter has gone offline and is attempting to re-connect (within 30 seconds)
		Alternating Green and Orange Reporter is currently online but has gone offline 2 or more times.

Manual Mode

The 2.0 Reporters with CFG 1.9 and greater come with a manual mode in case the general coach RV-C network fails. It will allow for limited operation while the larger network/module problem is addressed.

To determine the version of Reporter, the Reporter 2.0 modules are shipped with version decals affixed to the back of the circuit board, OR shown on the home screen - "FW: 2.0".

This mode can be accessed under the test page of the Aqua-Hot Reporter (see below).

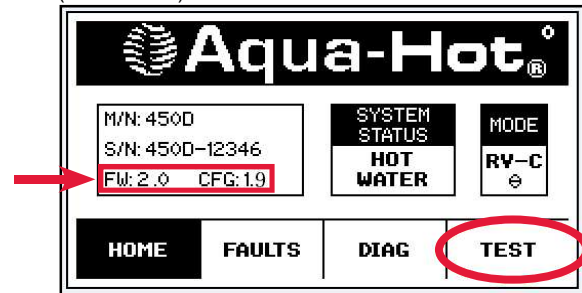

Figure 71

Once the test page is open, select the MANUAL MODE and select "NEXT". Manual mode will continue to run for up to 3 days without any user intervention. Pressing the reset button at any time while enabled will reset the timer, and run for an additional 3 days.

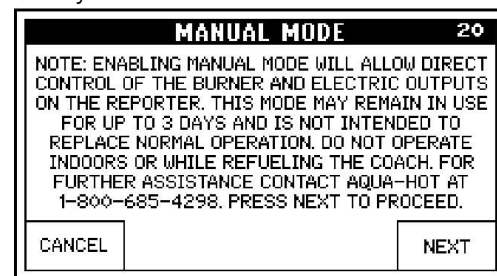

Figure 72

All heating zones are linked together and can be run at 25%, 50%, 75%, and 100% (as shown below). The burner and electric can be enabled or disabled. For all levels, there is a 10 minute duty cycle period that will allow Cozy fans to be on for the specified percentage of 10 minutes. Example, 25% would be on for 2.5 minutes, and then off for 7.5 minutes. It always starts with the on-cycle, then shuts off for the remainder of the 10 minute period.

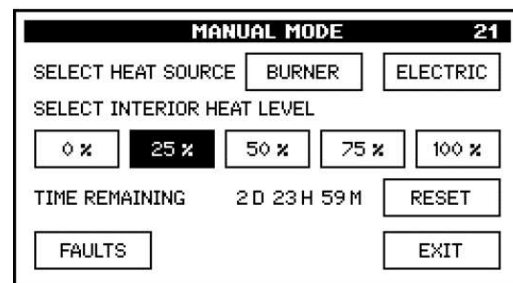

Figure 73

If the system power is cycled, the manual mode will be disabled and must be manually reactivated. Leaving the manual mode page will also disable manual mode and restore normal operation. Leaving manual mode should be done once the system failure has been resolved and normal operation can resume.

NOTE: If using the rocker switches, burner & electric switches must be toggled on/off after leaving Manual Mode.

Connecting the 450D to 12V DC Power

This section will outline the requirements, steps, and information necessary to connect the Aqua-Hot to the vehicle's 12V DC power system. Follow all guidelines and pay attention to all notes contained herein. Failure to adhere to these guidelines can inhibit unit performance, and may cause damage to the Aqua-Hot and/or the coach.

The Aqua-Hot is designed to shut down in the event that the DC voltage level drops too low to properly operate. It is imperative that the proper wire gauge be determined and utilized. Reference the schematics for proper wire gauge sizing. Please note that under full-load conditions, the Aqua-Hot can draw as much as 20 amps of DC current.

- Installation must be performed by a qualified, professional according to current national regulations. Reference A119.2/NFPA 501C Standard on Recreational Vehicles 1993 Edition for relevant national regulatory information.
- Select the correct wire gauge for installation referencing ANSI/RVIA-LV - see Page 45.
- Protect the Aqua-Hot from over-current and shorting by incorporating a 20A breaker (minimum) to the Aqua-Hot's coach-side power connection.
- The 12-volt supply to the heater must be routed directly from the battery.
- All power circuits must be protected with fuses or automatic circuit breakers.
- Reference the schematics starting on page 46 and Figure 74.
- The image below is simply a reference. A professional, licensed installer needs to determine the necessary components and configuration according to local codes and standards.

NOTICE

Do NOT activate the diesel burner until the antifreeze and water heating solution has been added to the boiler tank and the heating system has been completely bled of air. Operating the Aqua-Hot without the heating solution will cause serious damage to the Aqua-Hot's boiler tank.

Instructions:

1. Run and connect two wires, one red wire (+ power) and one black wire (- ground) from the vehicle's main battery disconnect to the Aqua-Hot's Reporter.
2. Label the wires indicating whether they are a power or a ground wire.
3. Attach the DC power wires onto the appropriate connections on the Reporter.
4. Connect both power and ground wires to the vehicle's battery through the vehicle's main battery disconnect.



CAUTION

DO NOT connect 12V DC power to the Aqua-Hot if the vehicle requires welding. Electrical welding will cause serious, irreversible damage to the Aqua-Hot.

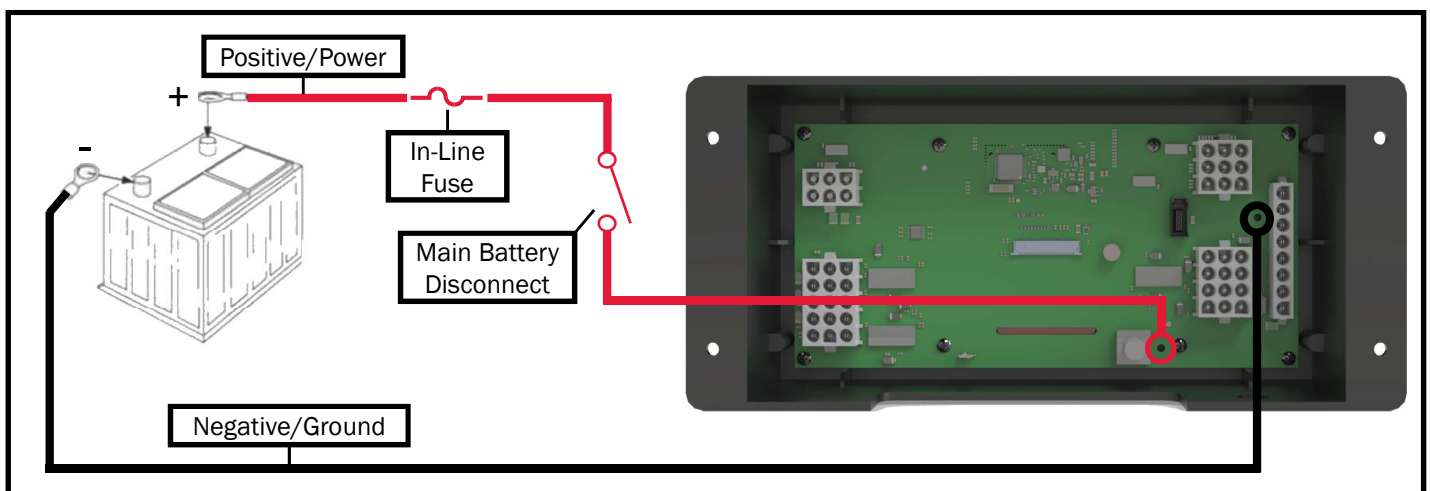

Figure 74

Connecting the 450D to 120V AC Power

The following section will detail how to connect the Aqua-Hot to the vehicle's AC electric system. Connect the 3-pin Molex connector to the coach-side AC electric system in order to utilize the Aqua-Hot's AC heating element.

- Installation must be performed by a qualified professional according to current national regulations. Reference A119.2/NFPA 501C Standard on Recreational Vehicles 1993 Edition.
- The boiler must be connected to a 120V AC supply permanently and be protected with a 20A breaker (minimum). The 120V AC must be separate from 12V DC.
- It must be possible to disconnect the power to the boiler, either an easily accessible plug or a circuit breaker.
- Please refer to the schematic on page 48.

Instructions:

1. Route and insert three 120V AC power source wires into the AC terminal block through the AC wiring port's cable clamp fitting and into the proper terminal. Reference Figure 76 and the schematic on page 48.
2. Secure the wires into their terminal by tightening the corresponding screw on the terminal block to 5 inch pounds using a slotted screw driver blade no larger than $\frac{1}{8}$ ". See Figure 75 for reference.

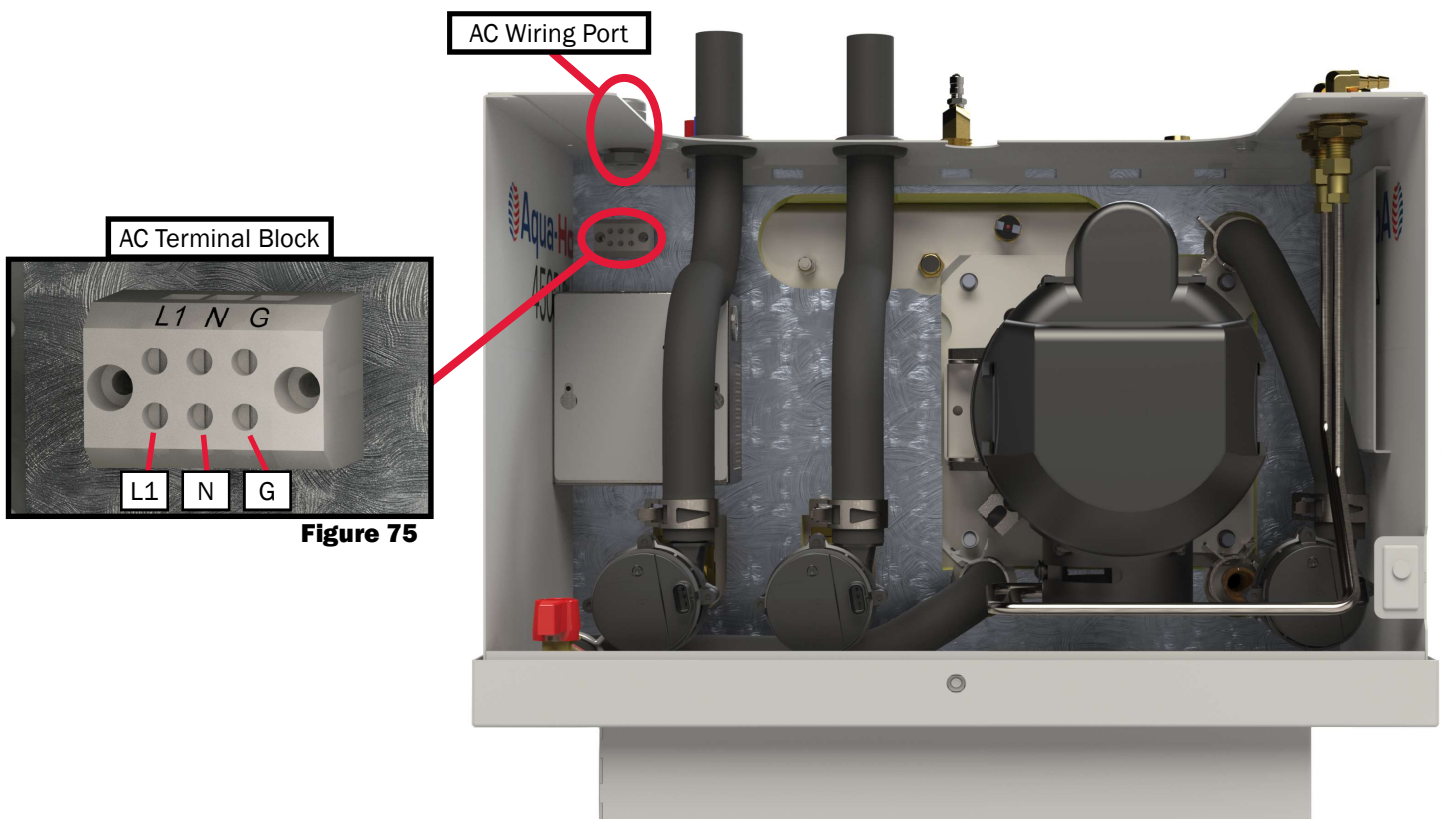

Figure 76

Filling the Aqua-Hot

Before the first activation of the Aqua-Hot, fill the unit with antifreeze and water heating solution. Without the solution present, the Aqua-Hot will not operate, it will not deliver hot water, and it will not deliver heat. Follow the directions below to fill the Aqua-Hot with antifreeze and water heating solution.

In order to provide the best freeze protection, boil-over protection, anti-corrosion, and rust protection, a mixture of 50/50 propylene glycol antifreeze and distilled water is recommended. The Aqua-Hot 450D boiler tank holds approximately 5 gallons.

Be sure to use a “GRAS” (Generally Recognized As Safe) boiler-type **propylene glycol** based antifreeze, rather than a RV and Marine antifreeze or an automotive antifreeze/coolant.

The mixture may be modified to provide the most adequate freezing, boiling, and rust/anti-corrosive protection. A 50/50 mixture of propylene glycol and distilled water has a freeze point of approximately -34°C (-29°F) and a boiling point of approximately 106°C (223°F). Reference Page 54 for properly measuring the antifreeze mixture with a refractometer.

Propylene Glycol												
Freeze Point (°C)	0	-4	-7	-9	-12	-15	-18	-23	-29	-34	-40	-46
Concentration (%)	0	12	19	25	30	34	38	44	49	53	57	60

Fill Instructions:

1. Locate the following items:
 - Exterior fluid pump (a diagram pump if possible)
 - The Aqua-Hot fluid expansion tank
 - A bucket or pale
2. Fill the bucket with the heating solution. Ensure the fluid expansion tank is connected to its port on the Aqua-Hot.
3. Open the Aqua-Hot’s drain valve located at the front of the heater. Reference Figure 78.

NOTE: The Aqua-Hot’s boiler tank must be filled with the antifreeze and water heating solution through the drain valve, not through the top of the unit, to avoid air traps.

4. Connect the external fluid fill pump to the fluid drain valve. A ½” NPT barbed fitting is best for this task.
5. Place the supply line of the external pump in the receptacle that contains the heating solution.
6. Locate the Reporter, and navigate to the “INPUTS FROM AQUA-HOT” page.
7. Pay attention to the “LOW LEVEL SENSOR” item on this page. See Figure 77.

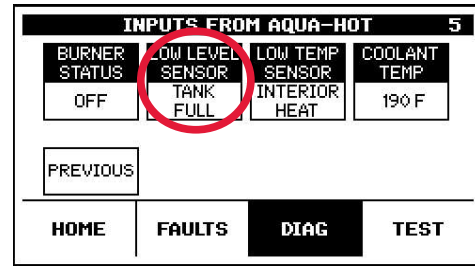

Figure 77

8. Fill the tank to approximately ¾ full, or until the “LOW LEVEL SENSOR” item displays “TANK FULL”.
9. Once the tank is partially full, deactivate the external fluid fill pump and close the drain valve. DO NOT disconnect the fluid pump.
10. Proceed to the next page to purge the zone before attempting to start the unit.

NOTE: Do not fill this unit completely. Filling the unit completely runs the risk of air-locking, preventing the heating zone from correctly circulating and draining the air.

CAUTION

Only propylene glycol based “boiler” type antifreeze deemed “GRAS” (Generally Recognized As Safe) by the FDA shall be used in the Aqua-Hot’s hydronic heating system. Failure to use the above specified antifreeze type could result in serious injury or death.

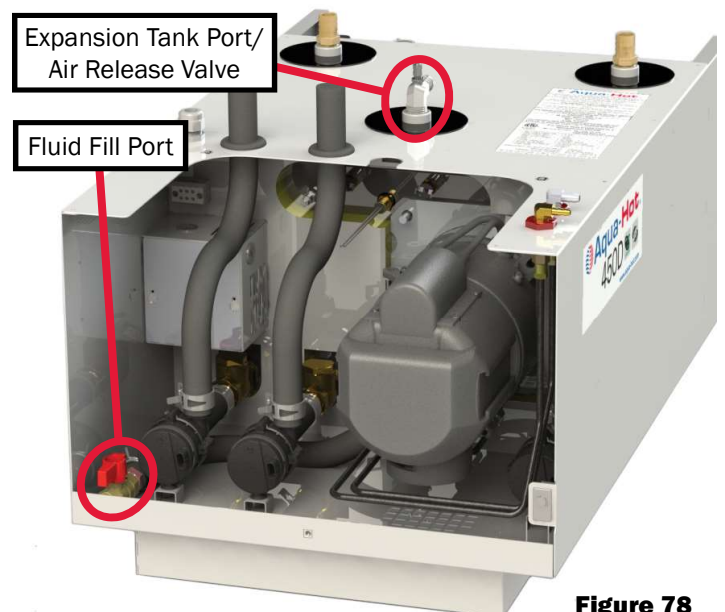

Figure 78

Purging the Interior Heating Loop

In order to provide interior heat to the vehicle, antifreeze and water heating solution is circulated within an interior “heating loop” which distributes heat throughout the coach. During installation, it is possible that air may become trapped within the heating loop and hamper unit performance.

Follow this procedure to purge any air from the interior heating loop.

Please note that if an RV-C or multiplex system is used in lieu of the Aqua-Hot display, you must contact the manufacturer, or connect a display to the on-board RV-C network to perform this procedure.

Purge Procedure:

1. Locate the fluid expansion tank of the Aqua-Hot. As any air is purged, it will exit through to this expansion tank.
2. Locate a gallon of glycol antifreeze. This will be used to top-off the fluid expansion bottle as air is purged from the system.
3. Navigate to the “PUMPS” page of the “TESTING” section on the Reporter as displayed below.

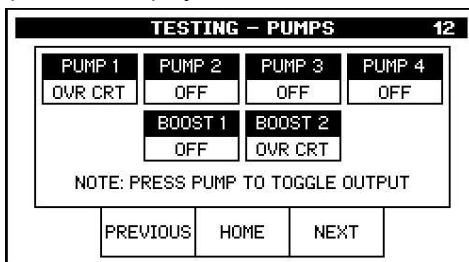

Figure 79

4. Tap each of the pumps to independently activate them, beginning the heating loop purge procedure. These pumps will remain active for a maximum of 5 minutes. They will need to be reactivated as needed until the purge procedure is complete (at least 20 minutes).
5. Continue to fill the unit as air is purged from the interior heating loop.
6. Once the air is no longer returned from the heating zone return ports, deactivate the fluid circulation pumps.
7. Open the fluid drain valve, and activate the external fluid fill pump. Fill the unit with GRAS propylene glycol antifreeze and water heating solution until it reaches the “COLD” mark on the fluid expansion tank.

Purging the Domestic Water System

NOTICE

Verify that the domestic water tank contains fresh water prior to bleeding the fresh water system of air.

Purge Procedure:

1. Ensure that the vehicle’s domestic water pump has 12V DC power, then activate it by opening each hot water faucet, one at a time, and running the water until all air is purged from the domestic water system.
2. Once the domestic water system is completely bled, check for any leaks in the system.

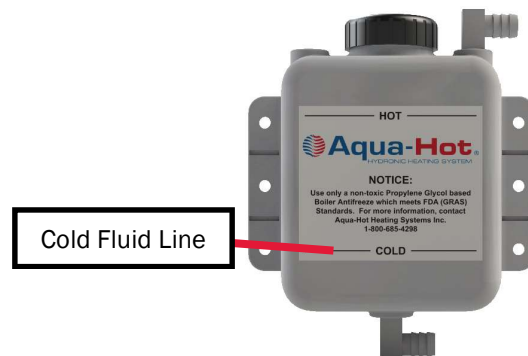

Figure 80

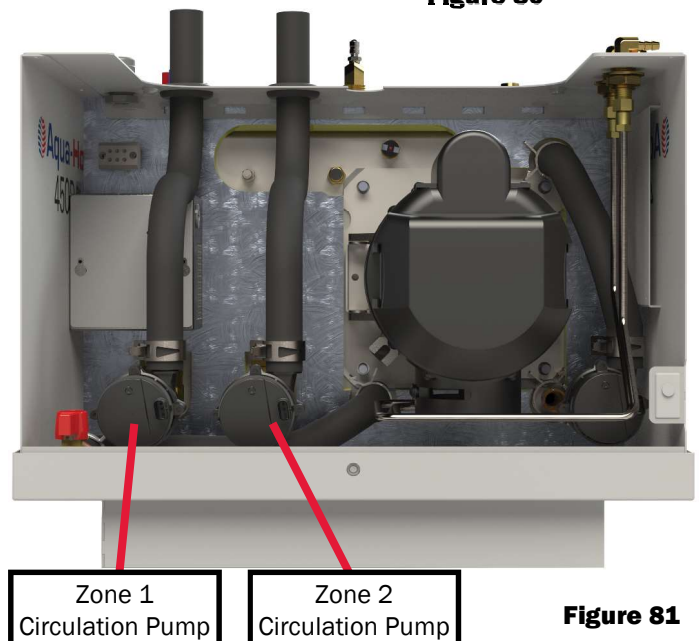

Figure 81

Aqua-Hot First Operation

Activation Instructions

1. Make sure power supply to the Aqua-Hot is on.
2. Confirm that the antifreeze and distilled water heating solution is adequately filled.
3. Confirm the system and heating loop has been properly purged of any air.
4. Make sure to flush the domestic water system thoroughly with clean water prior to use.
5. Reinstall the Aqua-Hot's main access cover and the fastener, which secures the front of the Aqua-Hot's access cover to the mounting tray.

NOTE: The main access cover must be installed prior to operation. A safety switch (interlock switch) exists, which will prevent the Aqua-Hot from operating whenever the main access cover is not properly or securely installed.

6. Move the diesel burner switch to the ON position for approximately 10 seconds ONLY, then switch it to OFF.

NOTE: This procedure will purge the diesel burner's fuel system, by allowing the heater's fuel pump to complete its normal 30-150 second shutdown/purge cycle.

7. After the purge cycle has ended, repeat once more.
8. Move the diesel burner switch to the ON position, and leave it on in order to activate the diesel burner.

NOTE: It will take approximately 10 seconds before the diesel burner will ignite and exhaust can be heard exiting the heater. Allow approximately 10-20 minutes for the Aqua-Hot to reach normal operating temperature (approximately 190°F).

9. Move the Aqua-Hot's electric element switch to the ON position in order to supply 120V AC power to the electric heating element.
10. Allow approximately 1-2 hours for the Aqua-Hot to reach normal operating temperature (~185°F).

NOTE: Both the 12V DC diesel burner and the electric heating element are thermostatically controlled. Either or both will automatically maintain the temperature of the boiler tank's antifreeze and water heating solution.

The Aqua-Hot is now ready for normal operation and use.

NOTICE

DO NOT activate the diesel burner until the antifreeze and water heating solution has been added to the boiler tank, and the heating system has been completely bled of air. Operating the Aqua-Hot without the antifreeze and water heating solution will cause serious damage to the Aqua-Hot boiler tank.

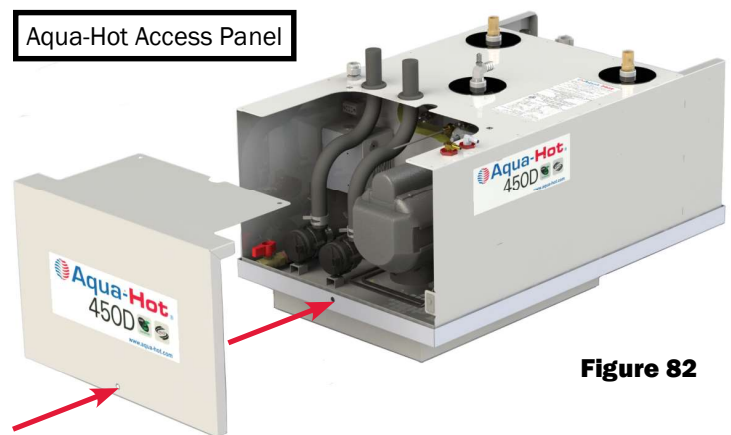

Figure 82

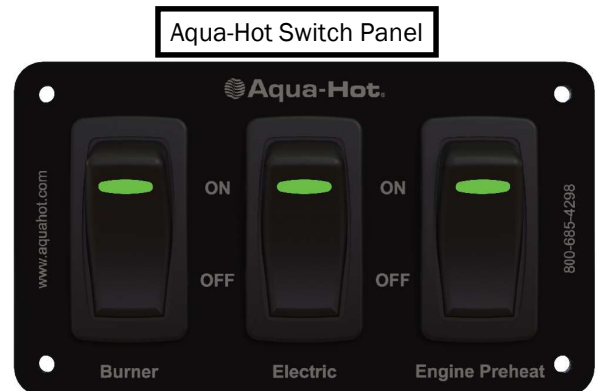

Figure 83

	<h2 style="margin: 0;">WARNING</h2>
	<p>Burn Hazard</p> <p>Hot Coolant Circuit with Hot Surfaces can cause sever burns.</p> <p>DO NOT touch or service until equipment has cooled.</p>

LDE-200-810

Winterizing the Aqua-Hot

The Aqua-Hot's domestic water heating system must be completely drained of domestic water at any time the heater is stored where freezing temperatures may be experienced.

Please follow these instructions when winterizing the Aqua-Hot domestic water heating system. Reference Figure 84 for a system overview.

NOTE: The Aqua-Hot can continue to be used for interior heat once the domestic hot water system has been winterized.

1. Completely drain the fresh water storage tank.
2. Disconnect the domestic water demand pump suction line from the fresh water storage tank.
3. Attach an adequate piece of hose onto the suction side of the domestic water demand pump.
4. Place the opposite end of the hose into an adequate supply of non-toxic RV winterization antifreeze (FDA certified as "GRAS" Generally Recognized As Safe must be used) and allow the fluid to pump through.
5. Open and close all interior and exterior water faucets one at a time, until ONLY pure RV antifreeze is present. Perform this procedure for both cold and hot water faucets.
6. Remove the hose and reconnect the domestic water demand pump's suction line to the fresh water storage tank.

WARNING

Not winterizing the Aqua-Hot when freezing temperatures are present will result in SERIOUS damage to the Aqua-Hot domestic water heating system. Ensure that only non-toxic RV antifreeze (FDA approved "GRAS" antifreeze) rated for winterization is used when winterizing this unit. The warranty does not cover freeze damage.

De-Winterization

To de-winterize the Aqua-Hot system, completely fill the fresh water storage tank. Open and close the interior and exterior faucets, one at a time, until only clear water is present.

NOTICE

Disinfecting the Domestic Water System

The Aqua-Hot Heating systems contain copper tubing and are not compatible to prolonged exposure to sodium hypochlorite (bleach or liquid bleach). Using products containing bleach, including water refreshers, may cause corrosion of the domestic water lines, resulting in a catastrophic failure of the Aqua-Hot system by creating leaks that cannot be repaired. This damage is not covered by the Aqua-Hot warranty.

If disinfecting the hot water system, be sure to follow NFPA 1192 Standard on Recreational Vehicles "Instructions for Disinfection of Potable Water Systems" or any other applicable local standards for Potable Water Systems.

NOTE: Extended exposure to household bleach will corrode the components of the Aqua-Hot will potentially dramatically shorten the operational lifetime of the Aqua-Hot. Under no circumstances is the Aqua-Hot to be exposed to household bleach for extended periods of time.

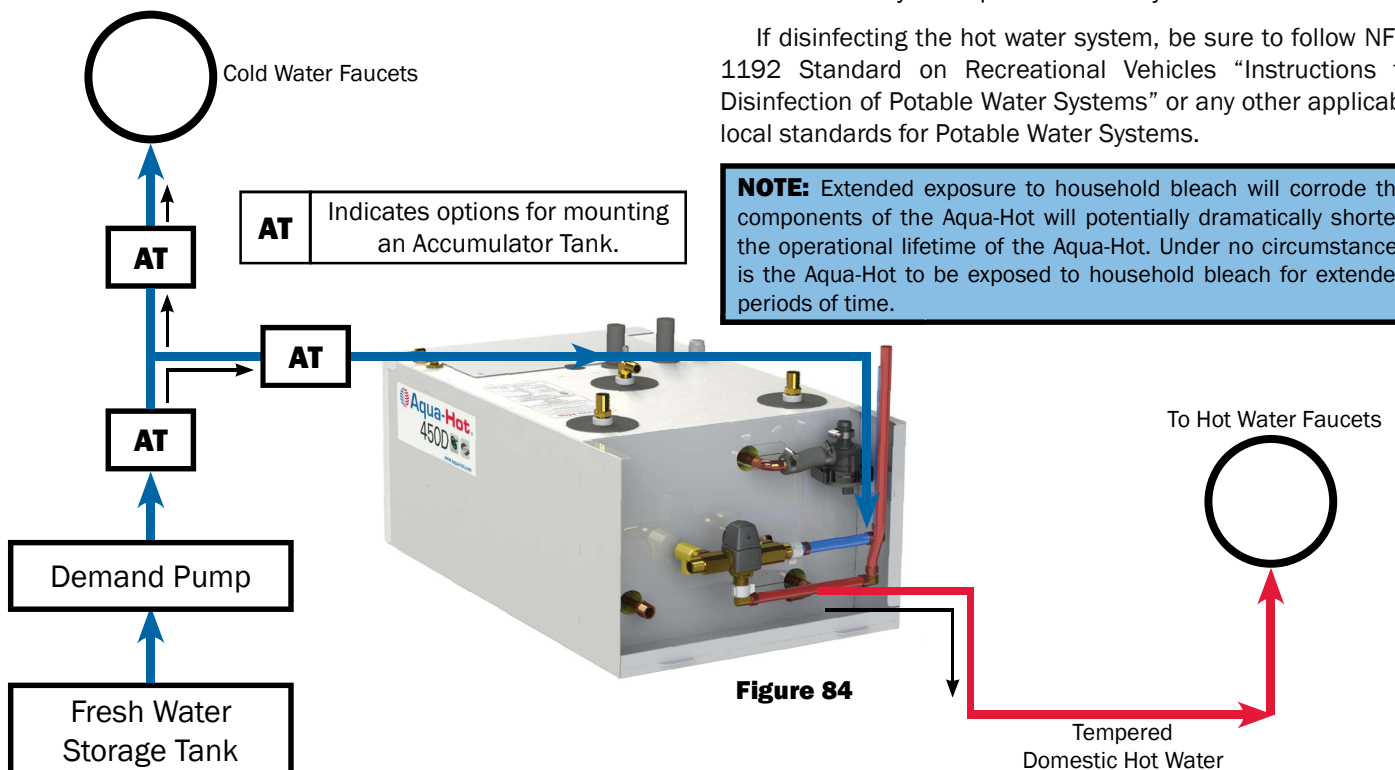
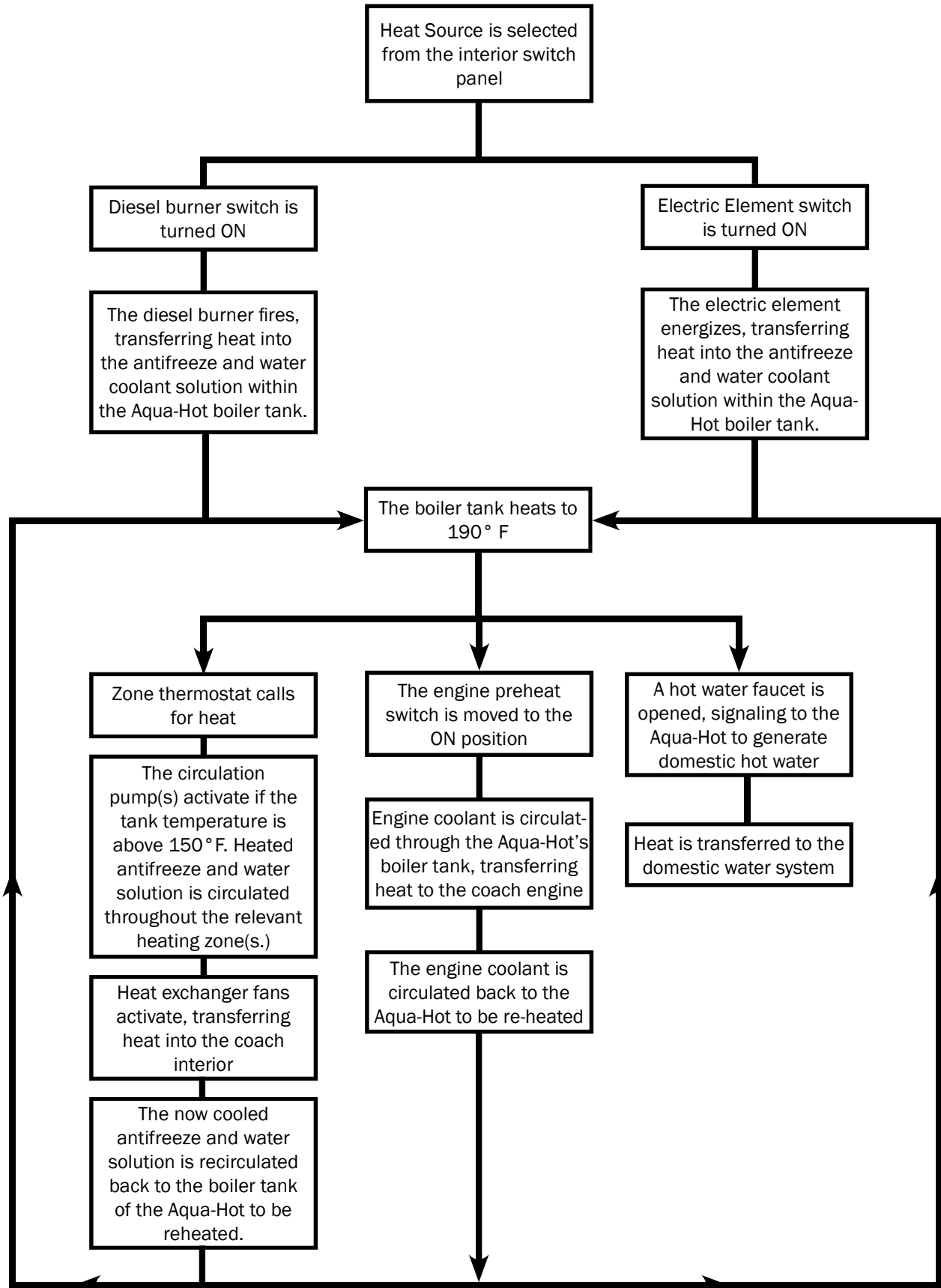

Figure 84

Operational Flow Chart



CONDUCTOR SIZING TABLE - MAXIMUM 10% VOLTAGE DROP - (12VDC)

CURRENT DRAW (AMPS)

	1	2	3	4	5	6	7	8	9	10	15	20	25	30	40	50	60	70	80	100
GAGE	MAXIMUM LENGTH OF SAE CONDUCTOR (in feet) FROM SOURCE TO DEVICE																			
20	107	53	36	27	21	18	15	13	12	11	7									
18	172	86	57	43	34	29	25	21	19	17	11	9								
16	261	130	87	65	52	43	37	33	29	26	17	13	10							
14	413	207	138	103	83	69	59	52	46	41	28	21	17	14						
12	651	326	217	163	130	109	91	81	72	65	43	33	26	22	16					
10	1043	521	348	261	208	174	149	130	116	104	70	52	42	35	26	21	17			
8	1653	827	551	413	331	276	236	207	184	165	110	83	66	55	41	33	28	24	21	
6	2892	1446	954	723	578	482	413	362	321	289	193	145	116	96	72	58	48	41	36	29
4	4170	2085	1390	1043	834	695	596	521	463	417	278	209	167	139	104	83	70	60	52	42

MAXIMUM LENGTH OF AWG CONDUCTOR (in feet) FROM SOURCE TO DEVICE

20	115	57	38	29	23	19	16	14	13	11	8									
18	182	81	61	45	36	30	26	23	20	18	12	9								
16	288	144	96	72	58	48	41	36	32	29	19	14	12							
14	458	229	153	115	92	76	65	57	51	46	31	23	18	15						
12	729	364	243	182	146	121	104	91	81	73	49	36	29	23	19					
10	1159	579	386	290	232	193	166	145	129	116	77	58	46	39	29	23	19			
8	1738	869	579	435	348	290	248	217	193	174	116	87	70	58	43	35	29	25	22	
6	2930	1465	977	733	586	488	419	366	326	293	195	147	117	98	73	59	49	42	37	29
4	4659	2330	1553	1165	932	777	666	582	518	466	311	232	186	155	116	93	78	67	58	47

OVER-CURRENT PROTECTION

AWG OR SAE Conductor Size Gage (Metric)	Maximum Ampacity at Conductor Insulation Temperature Rating of:		
	90° C	105° C	125° C
20 (.05)	10	10	15
18 (.08)	15	15	20
16 (1)	20	20	25
14 (2)	25	30	30
12 (3)	30	40	40
10 (5)	40	50	60
8 (8)	50	70	80
6 (13)	80	100	100
4 (19)	100	120	150
2 (32)	150	150	200

POWER INPUTS, PUMPS, AND SAFETIES

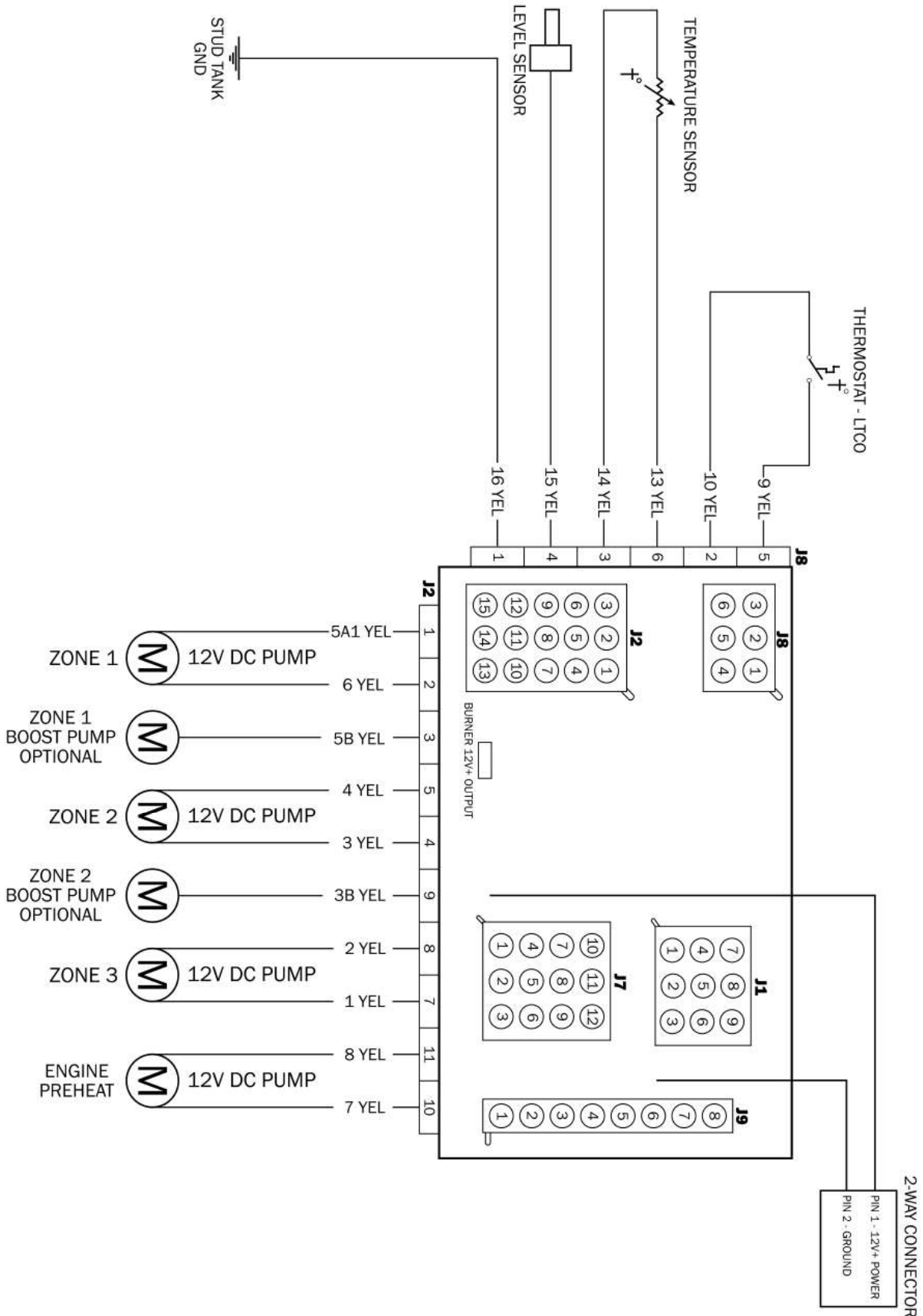

BURNER

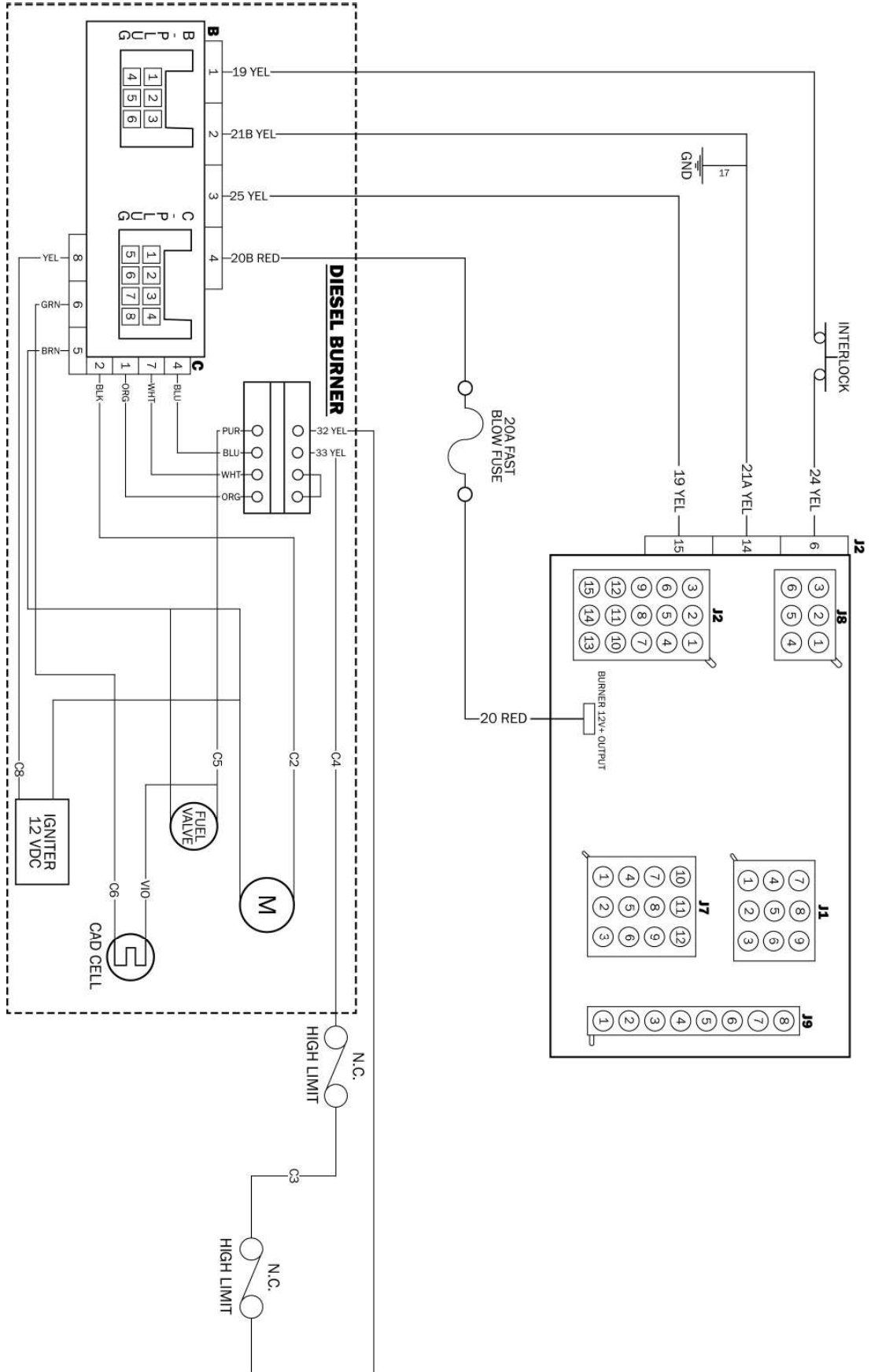

ELECTRIC ELEMENT AND HIGH-LIMIT THERMOSTATS

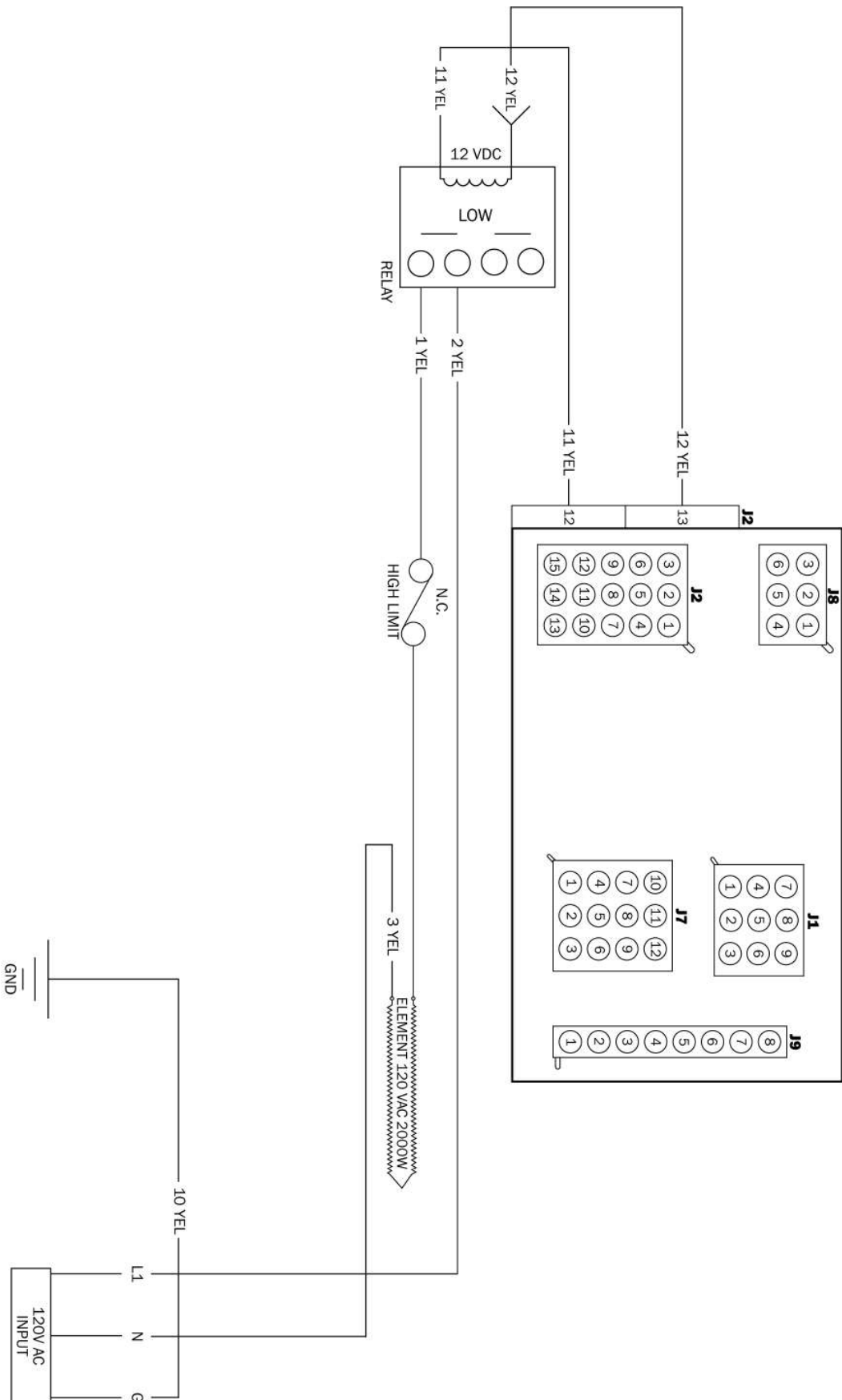

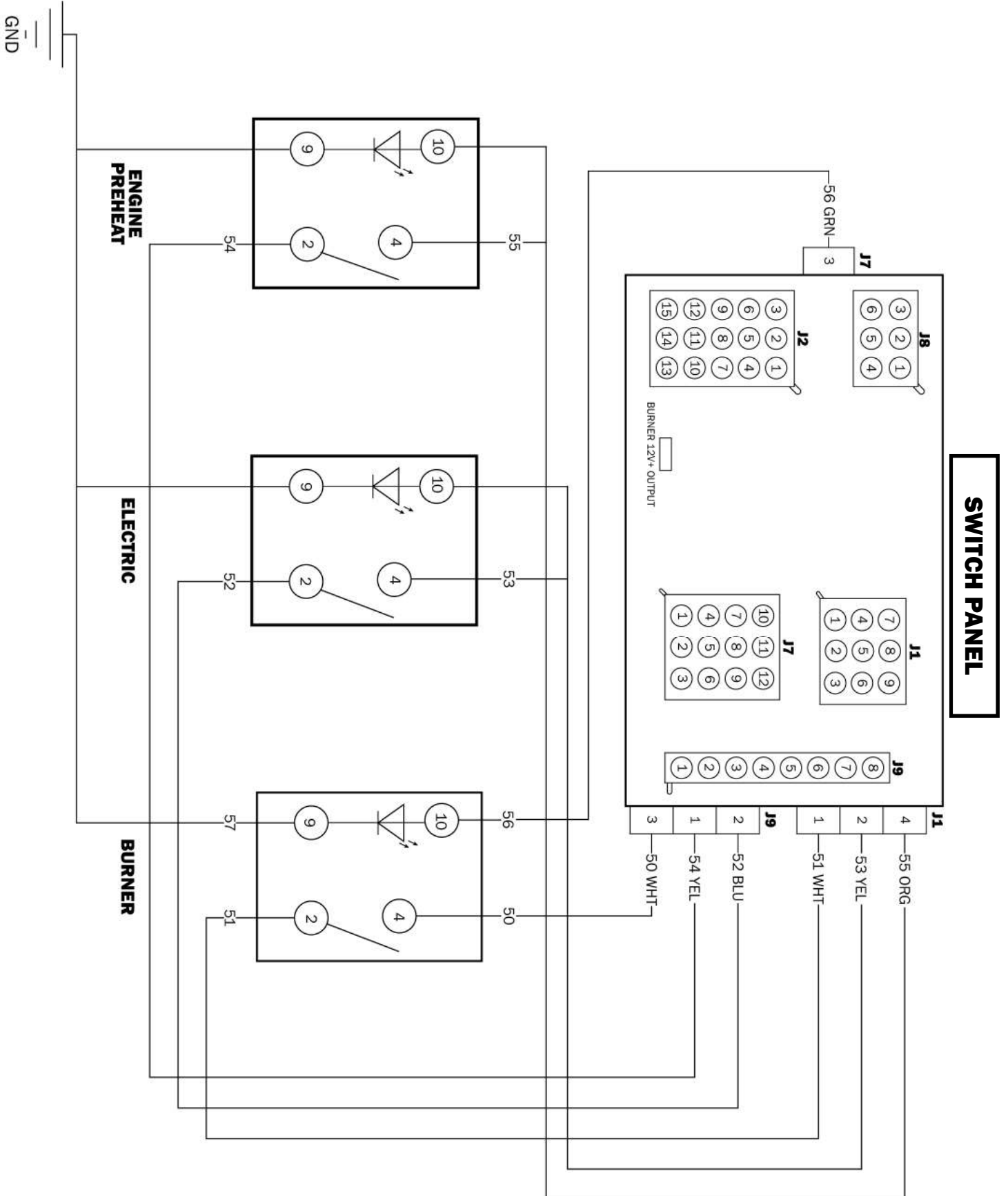

HEAT EXCHANGERS

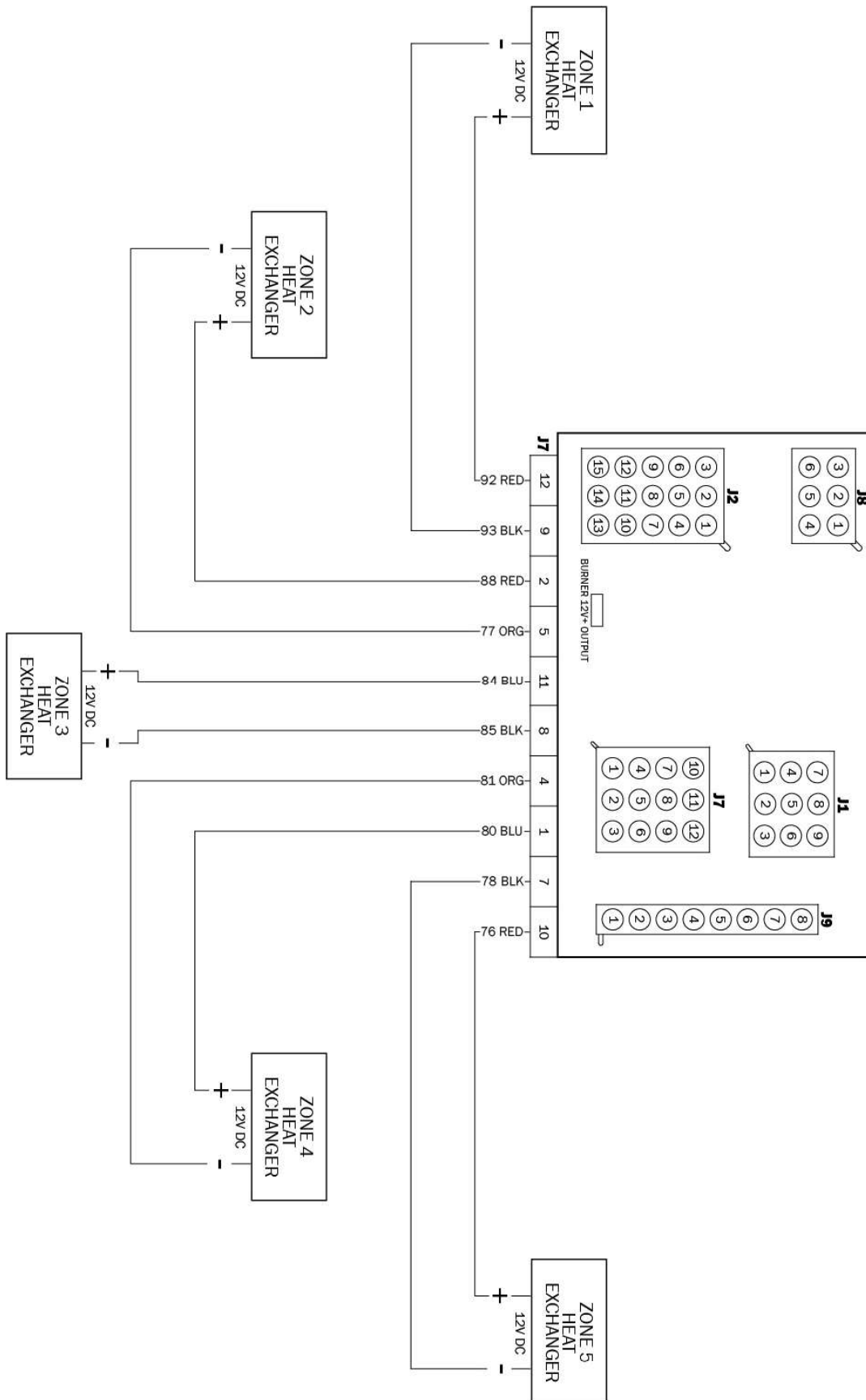

HEATING ZONES

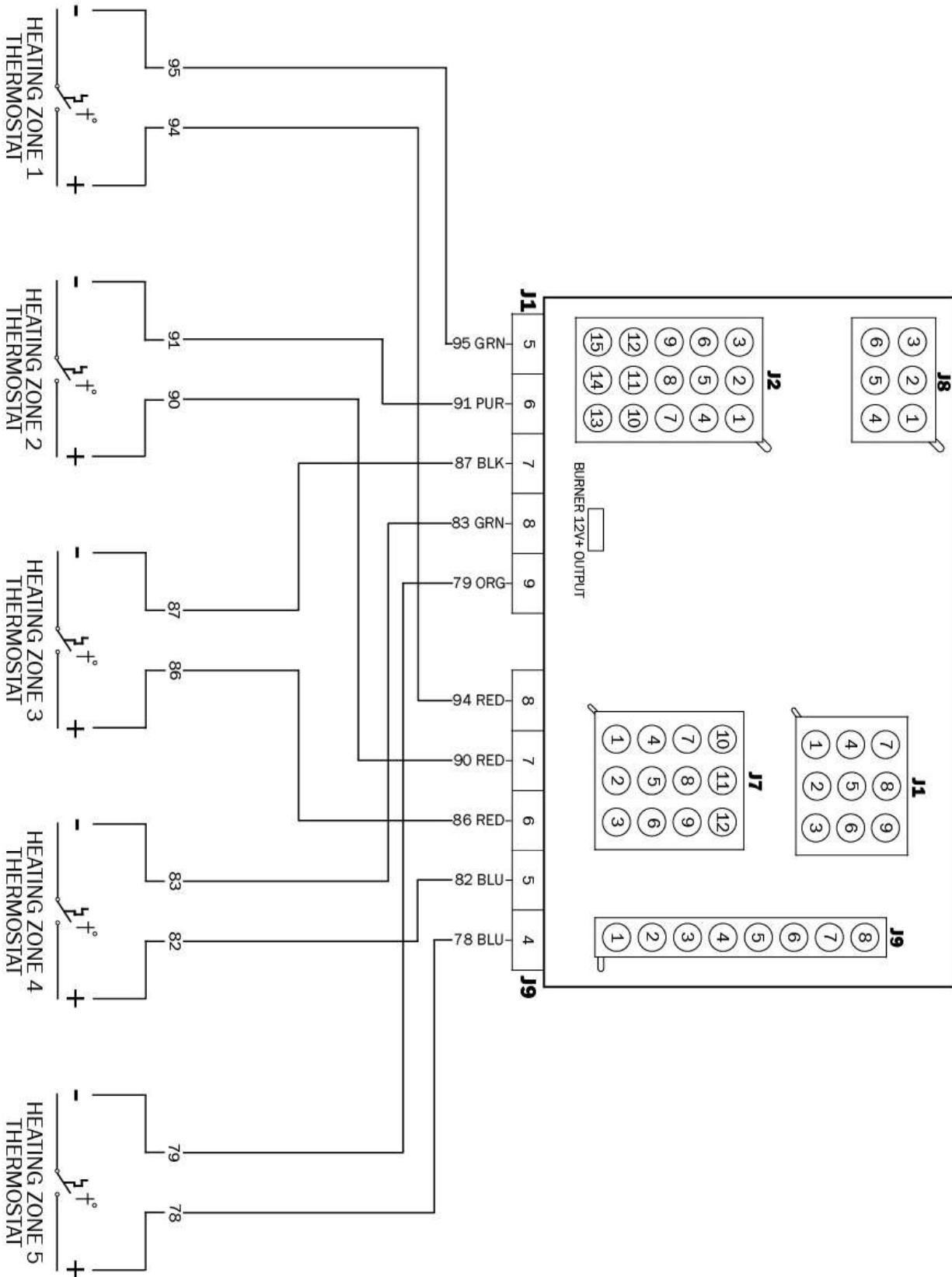

Antifreeze Types

The following information addresses the necessary usage of a propylene glycol based “boiler” type antifreeze in the Aqua-Hot. Propylene glycol is a safer alternative to the more toxic ethylene glycol antifreeze; however, as mandated by IAPMO (International Association of Plumbing and Mechanical Officials), only propylene glycol based “boiler” type antifreezes deemed “Generally Recognized As Safe” (GRAS) by the FDA should be utilized.

Due to the significant impact various types of antifreeze can have on a hydronic heating system, including the level of safety provided, it has been recognized that there is a need to provide an explanation regarding two additional prominent types of antifreeze/coolant available. The following information should be utilized as an educational means of ensuring that the proper type of propylene glycol based antifreeze is selected.

RV & Marine Antifreeze

These types of propylene glycol based antifreeze products are formulated specifically for “winterizing” applications only. Although RV & Marine antifreeze is often “Generally Recognized As Safe” by the FDA, it should never be used in the Aqua-Hot’s Hydronic Heating System. This type of antifreeze is not formulated to transfer heat, which is essential to the heating system’s functionality and does not contain rust inhibitors. Please note, however, that RV & Marine antifreeze can be utilized to winterize the Aqua-Hot’s Domestic Hot Water Heating Systems.

Automotive Antifreeze/Coolant

These types of propylene glycol based antifreeze products are formulated specifically to protect automotive engines against corrosion, freezing temperatures, and overheating. They also have excellent heat transfer and thermal conductivity characteristics. Although these types of antifreeze products are considered less toxic and safer than ethylene glycol for people, pets, and the environment, they are not “Generally Recognized As Safe” (GRAS) rated by the FDA. Therefore, they must be marked with a “harmful if swallowed” warning. This additional warning is required because these types of antifreeze products contain high levels of chemical rust inhibitors. Due to their potentially hazardous properties, they should never be used in the Aqua-Hot’s Hydronic Heating System.

Antifreeze Mixture Quality Recommendations

In order to ensure maximum performance and longevity of an Aqua-Hot heating system’s boiler tank and associated components, it has been determined that there is a need to use distilled, deionized, or soft water in combination with

concentrated propylene glycol for the Aqua-Hot’s antifreeze and water heating solution.

Please note that this is only necessary when mixing concentrated propylene glycol antifreeze with water; suppliers of premixed antifreeze are responsible for the use of high-quality (distilled, deionized, or soft) water when preparing their antifreeze for sale.

Hard water possesses a high-level of calcium and magnesium ions, which deplete the propylene glycol antifreeze’s corrosion inhibitors. This, in turn, causes the antifreeze and water heating solution to begin turning acidic, which can corrode the Aqua-Hot’s boiler tank and associated components prematurely. Therefore, concentrated propylene glycol should be diluted with distilled, deionized, or soft water which is 80ppm or less in total hardness. The local water agency should have up-to-date water quality reports, which should indicate if the local tap water is within this guideline.

Antifreeze Terms & Mixture Ratio

Propylene Glycol Based Antifreeze Solution

The following information addresses the process of selecting a propylene glycol based antifreeze solution that provides adequate freeze, boiling, and rust/anti-corrosive protection.

A propylene glycol antifreeze solution that is 35% to 50% propylene glycol to distilled water is recommended. Antifreeze solution with 50% propylene glycol will result in a freeze point of approximately -28 °F and a boil point of approximately 222 °F.

Freeze Point and Burst Point

NOTE: The installer of the Aqua-Hot system must refer to the information and chart to determine the percentage of propylene glycol the antifreeze solution should contain for the level of protection needed.

Antifreeze solution lowers the freezing point of any liquid, to which it has added, by preventing the formation of ice crystals. However, as the ambient temperature continues to decline, the water in the solution will attempt to attain a solid state. The point in which the water begins to solidify is termed the “Freeze Point”. Although the water in the solution has begun to freeze and starts producing a “slushy” consistency, the antifreeze in the solution will continue to combat the normal expansion of the solution as it freezes. The point in which the solution can begin to expand, due to colder temperatures, is called the “Burst Point”. Once the solution reaches the burst point, the potential is present for ruptured pipes to exist. The burst point of the antifreeze and water heating solution is dependent upon

the brand of propylene glycol antifreeze employed.

Rust and Anti-Corrosive Inhibitors

Another major function of antifreeze solution is to provide protection to the internal metal components of the Aqua-Hot Hydronic Heating System from corrosion and rust. Antifreeze is able to perform this function by the addition of rust and anti-corrosive inhibitors, which are designed specifically to activate in a water solution.

Summary

Antifreeze solution has three basic functions: freeze protection, boil-over protection, and rust/anti-corrosion protection.

Propylene glycol antifreeze solution is also primarily responsible for heat transfer; however, propylene glycol itself does not possess acceptable heat transfer characteristics.

Therefore, as water is an excellent heat conductor, it is added to the mixture. Propylene glycol antifreeze solution, mixed with distilled water, at a ratio of 35% to 50% is recommended to provide the best performance combination of the aforementioned functions. If excess propylene glycol exists within the heating solution, the water's heat absorption properties are compromised. Ultimately, this could inhibit the Aqua-Hot from providing adequate domestic hot water and interior heating.

Additionally, if the antifreeze and water heating solution contains over 70% propylene glycol, the freezing point is actually raised, resulting in less freeze protection. Please reference the attached graphical representation regarding the percentage of antifreeze to water and how it directly affects the solution's freezing point.

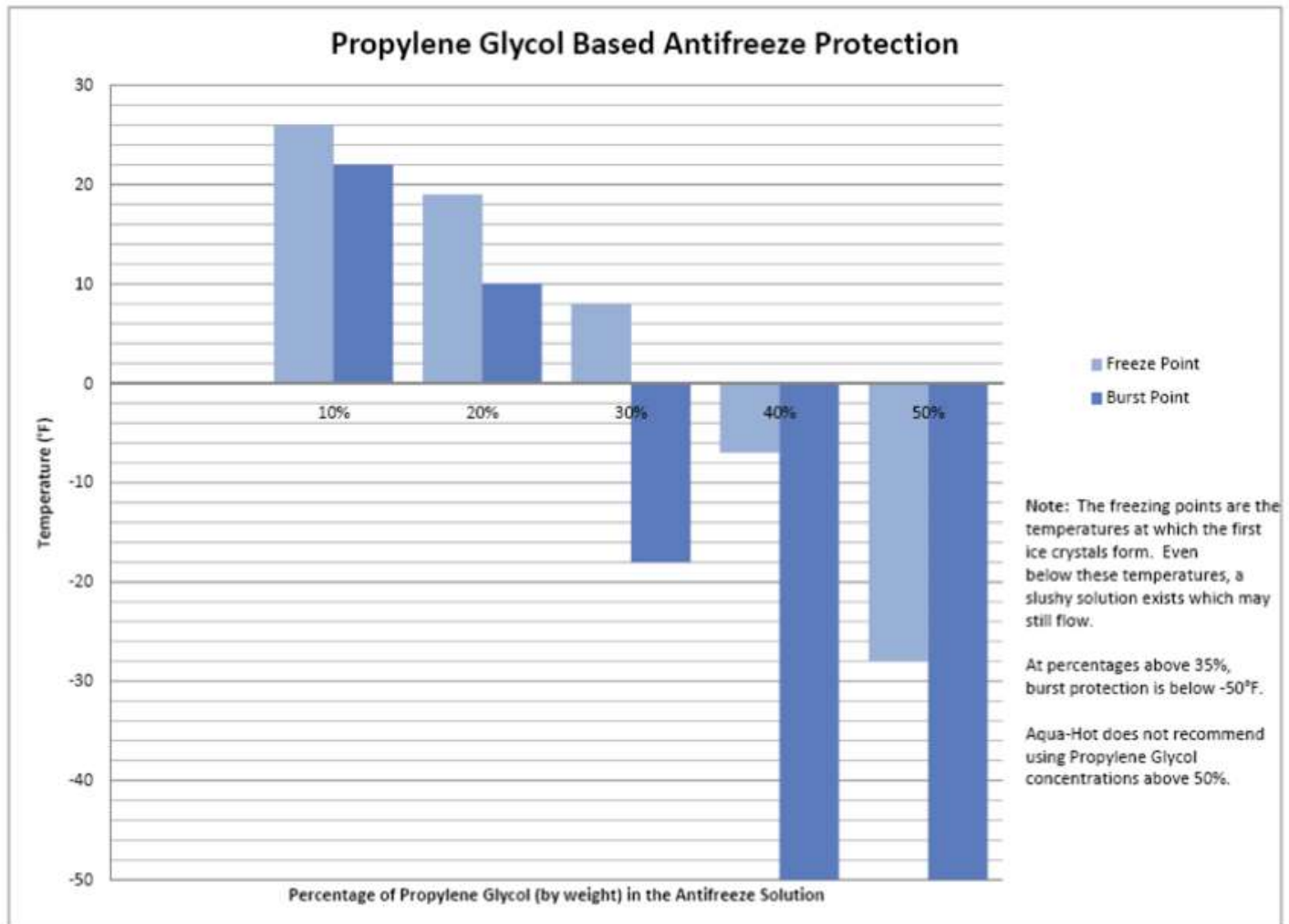

Measuring Antifreeze Using a Refractometer

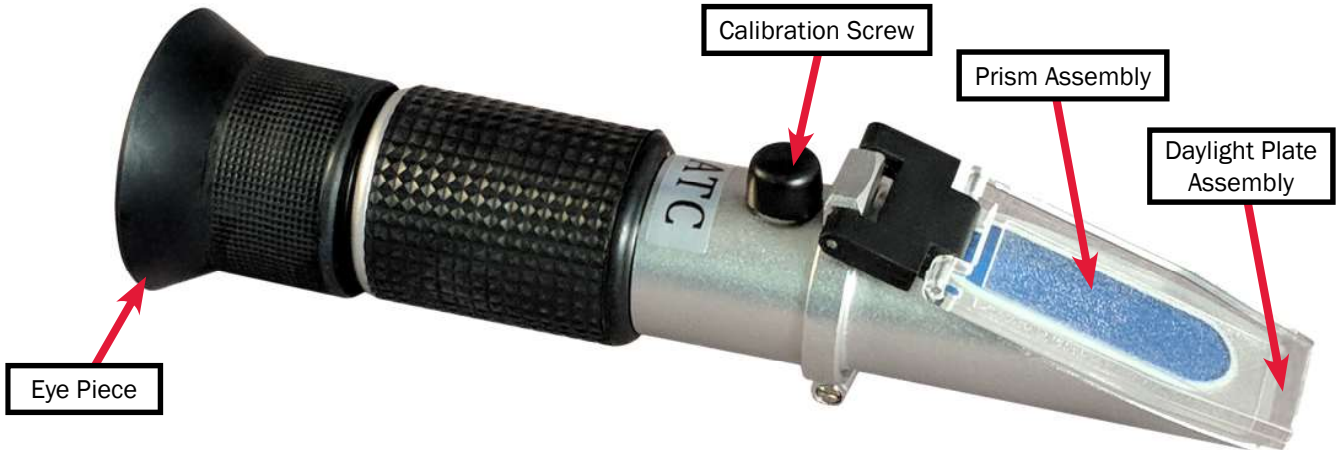

Properly Apply Antifreeze to the Prism Assembly

Use the guide below to properly apply the propylene glycol mixture to the prism assembly of the refractometer. Once that is complete, peer through the eyeglass of the refractometer to continue to the next step.

Adjust the Boundary Line

Once the glycol solution has been properly applied, adjust the calibration screw until the boundary line labeled "Propylene Glycol" is set to 32 °F. The graphic to the right has been designed as an aid, but note that it may differ from what is shown in the refractometer sight glass.

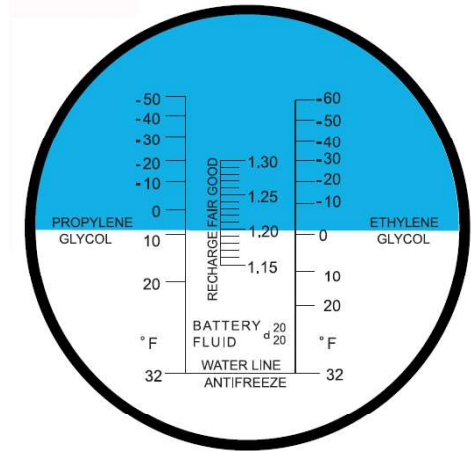

Refractometer Sight Glass

Application of Propylene Glycol

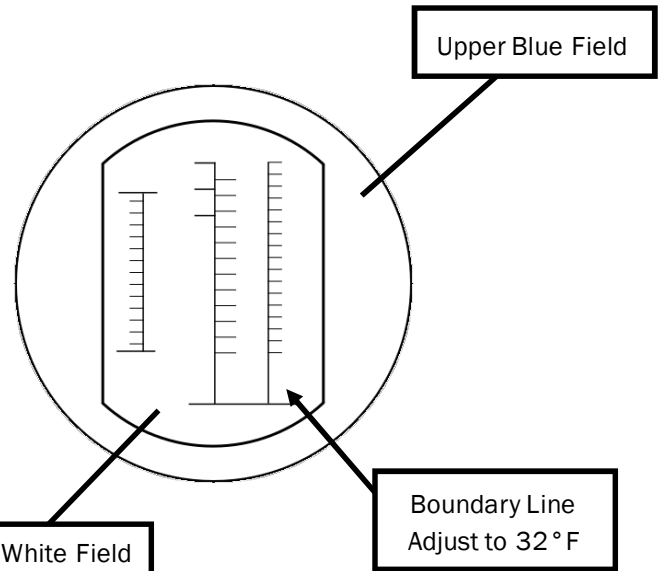
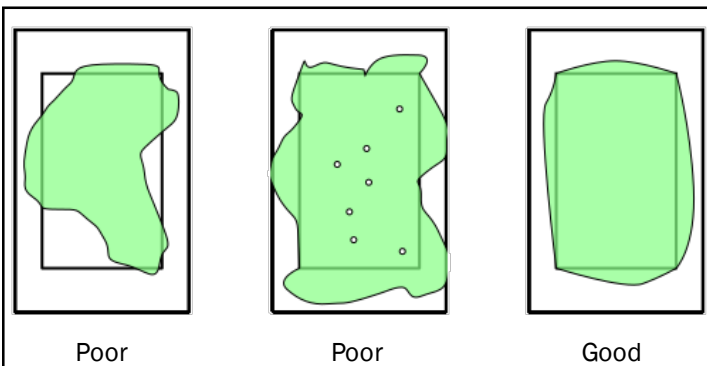



AHE-450-DE5



ELE-000-509
Panel, Switch, 3 Position ASM



ELE-400-900
Boost Pump Harness

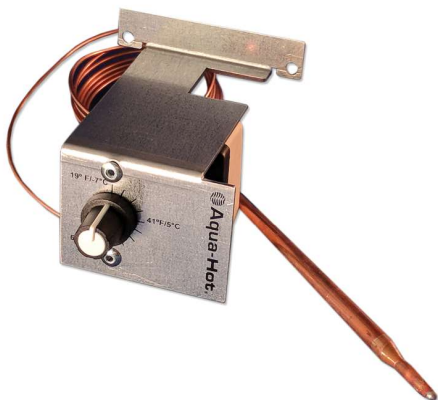

ELX-500-510
Bay Thermostat



ELX-700-007
Room Thermostat, Positive Off



EXE-103-OEX
Heat Exchanger, Cozy III



EXE-505-65A
Heat Exchanger, Whisper Silent, 12V DC.



EXX-006-500
Grille, Long, 3.5" x 21.5", Black

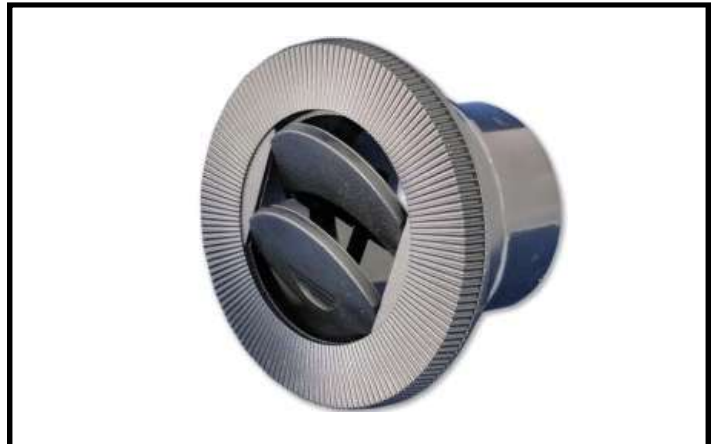

EXX-013-100
Nozzle, Round 4" w/o Connector, Black



EXX-013-105
Nozzle, 4" Round w/ 2 1/2" Connector, Black



EXX-950-411
Grille, 10" x 2" Cozy



EXX-006-501
Grille, Medium, 3.5" x 15", Black



EXX-006-502
Grille, Small, 3.5" x 8.5", Black



PLE-070-401
Tank, 3 QT, Expansion Assembly



PLX-000-200
Tube, 5/8" Safety Stripe, 12ft.



PLX-000-820
Fitting, Elbow, 90°, 3/4", Barb, Black Nylon



PLX-000-835
Fitting, Reducer 3/4" to 5/8" Black Nylon



PLX-100-836
Pump Mounting Bracket



PLX-100-900
Boost Pump



PLX-120-626
Tube, 5/8", Red O2 Barrier Pex 100 Ft.



PLX-200-103
Fitting 1/2" (M) NPT x 3/4" Barb Black Nylon



PLX-284-74V
Hose, Molded, Elbow 90°



PLX-432-000
Fitting, Straight, 1/2" PEX x 1/2" (M)NPT PSF



PLX-664-730
Fitting, Pipe Nipple, Exhaust, 1 1/2" x 4"



PLX-664-750
Fitting, Exhaust Nipple, 1 1/2" x 3" NPT



PLX-803-000
Fitting, Straight, 1/2" PEX x 1/2" (F) NPT



PLX-803-ELB
Elbow Fitting, 90°, 1/2" PEX x 1/2" PSF



PLX-803-FSE
Elbow Fitting, 90°, 1/2" PEX Fitting



PLX-CTB-270
Clamp, Hose, Constant Tension, 0.75"



PLX-A51-106
Bend Support, 5/8"



PLX-A65-200
Fitting, Brass Barb, 3/4" x 1/2" (M) NPT



PLX-A65-300
Fitting, Brass Barb, 90°, 3/4" x 1/2" (M) NPT



PLX-T44-006
Fitting, Insert Modified Bras



SME-102-000
Cozy Plenum Assembly



2-YEAR LIMITED WARRANTY AQUA-HOT® HYDRONIC HEATING SYSTEM

Aqua-Hot Heating Systems Inc. warrants the Aqua-Hot Heater to be free from defects in material and workmanship under normal use and service for a period of two years on both parts and labor commencing upon the original date of registration of the vehicle. Replacement parts are warranted for the remainder of the Heater's standard warranty coverage or for six months, whichever is greater. The intent of this warranty is to protect the heater's end-user from such defects, which would occur in the manufacturing of the product. Thus, problems due to improper specifications, improper installations, improper use, the use of accessory parts or parts not authorized by Aqua-Hot Heating Systems Inc., repair by unauthorized persons, and damage or abuse of the heater are specially excluded from warranty coverage.

For additional information, or to obtain a warranty repair authorization, please contact the Aqua-Hot Heating Systems Warranty Administrator at 574-AIR-XCEL (574-247-9235) (7:00 AM to 4:00 PM Mountain Standard Time) or visit www.aquahot.com.

My Comfort Zones are On-Board

Vehicle:

Purchased From:

Dealer Information:

Name:

Location:

Phone Number:

Heating System:

Serial Number:

Installation Manual

400_{SERIES}

 **Aqua-Hot**[®]
An AIRXCEL Brand



Aqua-Hot Heating Systems, LLC
7501 Miller Drive, Frederick, CO 80504

Visit us online at www.aquahot.com
Call us at 574-AIR-XCEL (574-247-9235).

©2021 Aqua-Hot Heating Systems, LLC. Printed in the USA