



By Vehicle Systems, Inc.

Motor Coach Heating Specialists

OWNER'S MANUAL

Model Number

HHE-200-08E - 12 VDC.

HHE-500-08M - 12 VDC.

OWNER'S INFORMATION

Owner's Name: _____

Address: _____

City: _____ State: _____ Zip Code: _____

Telephone: _____

E-mail Address: _____

Motorhome Model: _____

Date of Purchase (Motorhome): _____

Hydro-Hot Model No. (reference Figure 1 "Marking Plate"): _____

Hydro-Hot Serial No. (reference Figure 1 "Marking Plate"): _____

Please Mail To: Vehicle Systems' Warranty Department
15549 East Highway 52
Ft. Lupton, CO 80621

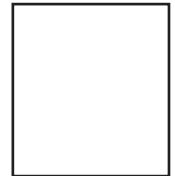

Vehicle Systems, Inc.
Warranty Department
15549 East Highway 52
Ft. Lupton, CO 80621

CUT HERE AND MAIL IN

TABLE OF CONTENTS

Section 1	Overview	
	1.0 Hydro-Hot Overview.....	1
Section 2	Operating Instructions	
	2.1 Activating the Hydro-Hot Heating System.....	4
	2.2 Zone Thermostat(s) Operation.....	6
	2.3 Using the Domestic Hot Water System.....	6
	2.4 Using the Engine Preheat System.....	7
	2.5 Diesel-Burner Component Overview.....	9
	2.6 Diesel-Burner Operational Flow-Chart.....	10
	2.7 Precautions.....	12
Section 3	Maintenance	
	3.1 Maintenance Schedule.....	13
Section 4	Winterization	
	4.1 Domestic Hot Water System.....	15
Section 5	Troubleshooting	
	5.1 General Information.....	17
	5.2 Electronic Controller Diagnostic.....	18

SECTION 1: OVERVIEW

Hydro-Hot Overview

1.0 Activating the Hydro-Hot Heating System

The Hydro-Hot Heating System is an on-board Hydronic Heating System (heating with hot water) that provides a continuous, on-demand supply of domestic hot water, as well as interior zone heating where and when it is needed. Both heating features are accomplished by a unique VDC-Powered Diesel-Fired Burner and a VAC-Powered Electric Heating Element (120 VAC). These two heating sources maintain the temperature of the Hydro-Hot's solution of water and antifreeze. In addition, the Hydro-Hot has been designed to preheat the vehicle's engine prior to starting (HHE-200 Model Only). This preheat feature provides an easy engine start-up whenever cool weather conditions are present. Be sure to review Figure 1A and 1B for complete component overview.

NOTE: This Hydro-Hot product utilizes a Propylene Glycol (P.G.) based water and antifreeze solution. This P.G. based solution is a Boiler type antifreeze, which is Generally Recognized as Safe ("GRAS") by the FDA. For additional information regarding this GRAS antifreeze product, please contact us at 1-800-685-4298 or visit our website at www.vehiclesys.com.

SECTION 1: OVERVIEW

Hydro-Hot
Overview,
continued

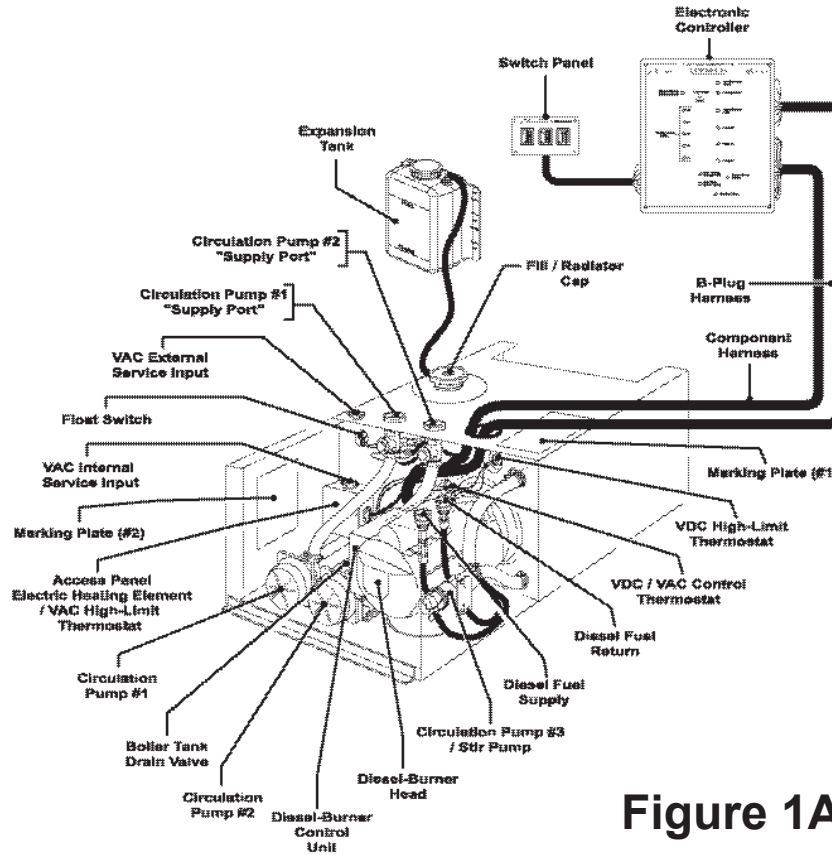

Figure 1A

SECTION 1: OVERVIEW

Hydro-Hot
Overview,
continued

REAR VIEW

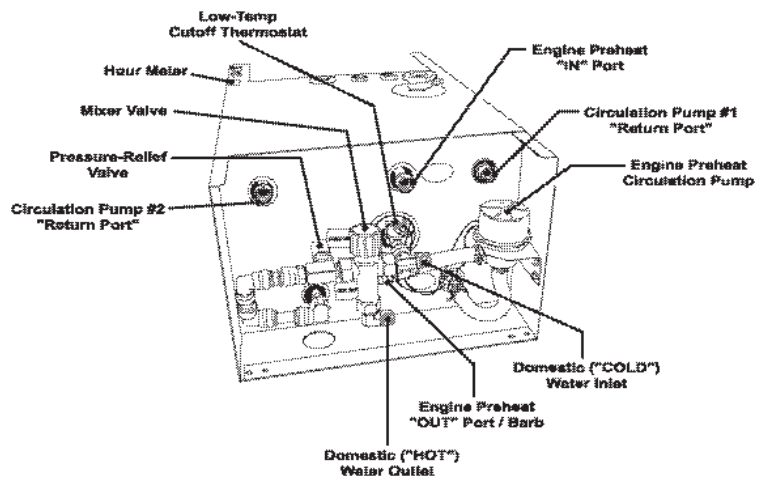

Figure 1B

SECTION 2: OPERATING INSTRUCTIONS

Heat Sources

Please read the complete Owner's Manual prior to operating your Hydro-Hot Heating System. Also, be sure to fill out and mail in your Owner's Information Card located at the front of this manual.

2.1 Activating the Hydro-Hot Heating System

Diesel-Burner

Turn the Diesel switch ON, reference Figure 2. This procedure will activate the Diesel-Burner and the indicator light located on the Diesel switch. Allow 10-20 minutes for the Hydro-Hot System to reach operating temperature. Please note that the Diesel-Burner is the primary heat source for heating both the interior and the domestic hot water (such as when cool ambient temperatures exist and/or when there is a high demand for domestic hot water).

Electric Heating Element

Turn the Electric switch ON, reference Figure 2. This procedure will activate the 120 VAC Electric Heating Element and the indicator light located on the Electric switch. Allow 1-2 hours for the Hydro-Hot System to reach operating temperature.

Also, please note that the Electric Heating Element is a secondary heat source for heating both the interior and the domestic hot water during low heating demand situations (such as when moderate ambient temperatures exist and/or when there is a low demand for domestic hot water).

NOTE: Both the Diesel-Burner and the Electric Heating Element are ther-

Page 4

SECTION 2: OPERATING INSTRUCTIONS

Heat Sources, continued

NOTE: Both the Diesel-Burner and the Electric Heating Element are thermostatically controlled. Either, or both, heating sources will automatically maintain the temperature of the Hydro-Hot's water and antifreeze solution between approximately 160-190 (+/- 5) degrees Fahrenheit. So to heat your motorhome / domestic hot water, simply choose the desired heat source(s) and leave the switch(s) (i.e. Diesel and/or Electric) ON.

Page 5

SECTION 2: OPERATING INSTRUCTIONS

Comfort Control

2.2 Zone Thermostat(s) Operation

Interior Room Thermostats

Simply adjust each Interior Room Thermostat to the desired temperature. Then whenever an Interior Room Thermostat “calls-for-heat”, the Hydro-Hot’s Circulation Pump(s) and Interior Heat Exchanger Fans will be activated. These devices together will supply warmth and comfort to each interior heating zone. Please contact your specific motorhome manufacturer for the exact location of the Interior Room Thermostat(s).

Fresh Water Tank Thermostat

Simply adjust the Thermostat (i.e. Bay Heating) to approximately 40 degrees Fahrenheit. This will prevent freezing of the domestic water storage system. Please contact your specific motorhome manufacturer for the exact location of the Fresh Water Tank Thermostat.

Hot Water

2.3 Using the Domestic Hot Water System

When the Hydro-Hot is at operating temperature, the domestic water is automatically heated as it is being used. Because the Hydro-Hot does not store any hot water, simply open any hot water faucet and a continuous supply of domestic hot water will be present within a few seconds. This hot water feature is continuous and is accomplished by the Hydro-Hot’s Domestic Hot Water Heating System. Please note that the Diesel switch must be ON to get an unlimited supply of hot water (i.e. during showers).

Page 6

SECTION 2: OPERATING INSTRUCTIONS

Hot Water, continued

NOTE: The Hydro-Hot’s “Domestic Water Priority System” disables the interior Zone Heating Fans, Zone Circulation Pumps, and the Engine Preheat Pump (if applicable) whenever domestic hot water is being used on a continuous basis (i.e. during showers). Once the demand for continuous domestic hot water ceases the Hydro-Hot will enable the Fans and Pumps to operate and provide heat to the Heating Zones. Please note that the Electronic Controller’s Low Temperature Cutoff Status indicator light will illuminate GREEN whenever the Hydro-Hot is able to provide zone heating, reference Figure 5.

Engine Preheat

2.4 Using the Engine Preheat System

Engine Preheat (HHE-200 Model Only)

When the Hydro-Hot is at operating temperature, and the Diesel-Burner and/or the 120 VAC Electric Heating Element switch is ON, follow these simple instructions:

A. Turn the Hydro-Hot’s Engine Preheat switch ON, reference Figure 2. This procedure will activate the Engine Preheat Circulation Pump and circulate the engine’s coolant through the Engine Preheat System. This feature will adequately warm the engine for easy start-ups on cool mornings.

Page 7

SECTION 2: OPERATING INSTRUCTIONS

Engine Preheat, continued

NOTE: Allow approximately 1 to 2 hours of engine preheating run time. Pre-heat duration will be shortest when the Diesel switch is ON.

B. Turn OFF the Aqua-Hot's Engine Preheat switch whenever engine preheating is not desired.

NOTE: The Hydro-Hot's Engine Preheating System acts as a supplemental heating source, in addition to the Diesel-Burner and the Electric Heating Element. While traveling, the engine's heated coolant will automatically pass through the Engine Preheat / Motoraid System, transferring heat into the Hydro-Hot's Boiler Tank. This design feature reduces the total operating hours of the Diesel-Burner and the Electric Heating Element.

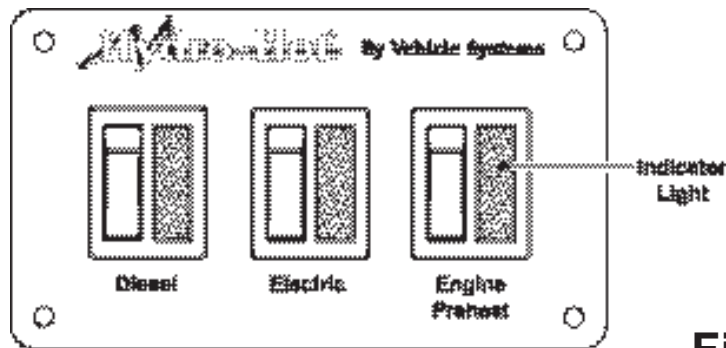

Figure 2

Page 8

SECTION 2: OPERATING INSTRUCTIONS

Diesel-Burner Component Overview

2.5 Diesel-Burner Component Overview

- | | | |
|--------------------------|------------------------|---|
| 1. Control Unit | 6. Fuel Solenoid | 11. Combustion Chamber |
| 2. Motor | 7. Electrode Holder | 12. Exhaust Port |
| 3. Ignition Coil | 8. Ignition Electrodes | 13. Flame Sensor |
| 4. Clutch | 9. Fuel Nozzle | 14. Fuel Pump |
| 5. Combustion Air Blower | 10. Heat Exchanger | 15. Fuel Ports (Supply / Return) |
| | | 16. Combustion Air Intake Port, with Adjustable Shutter |

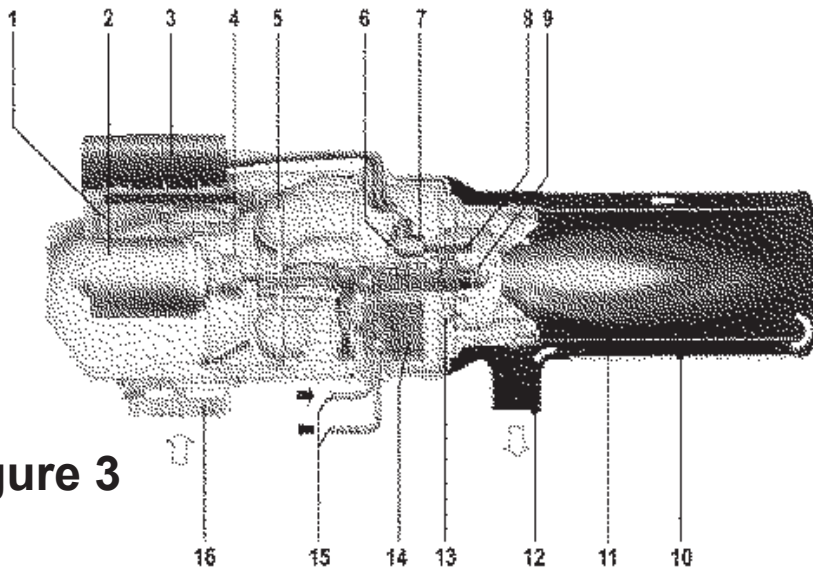

Figure 3

Page 9

SECTION 2: OPERATING INSTRUCTIONS

Diesel-Burner Operational Flow-Chart

2.6 Diesel-Burner Operational Flow-Chart

~ Reference Figure 3 for all numbers indicated inside parenthesis. (e.g. #8).

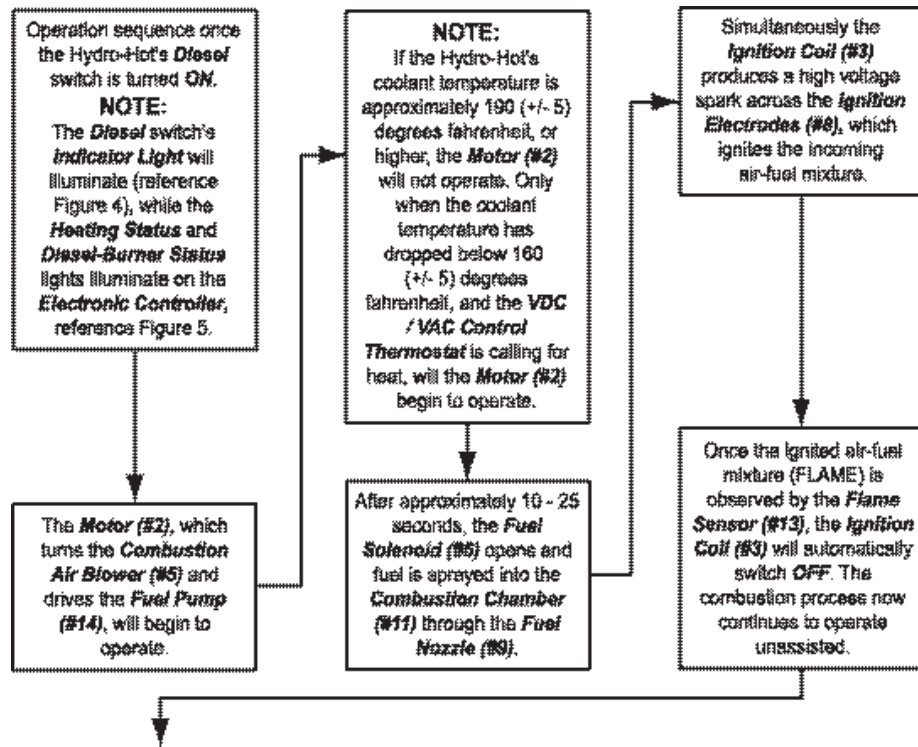

SECTION 2: OPERATING INSTRUCTIONS

Diesel-Burner Operational Flow-Chart, continued

2.6 Diesel-Burner Operational Flow-Chart, continued

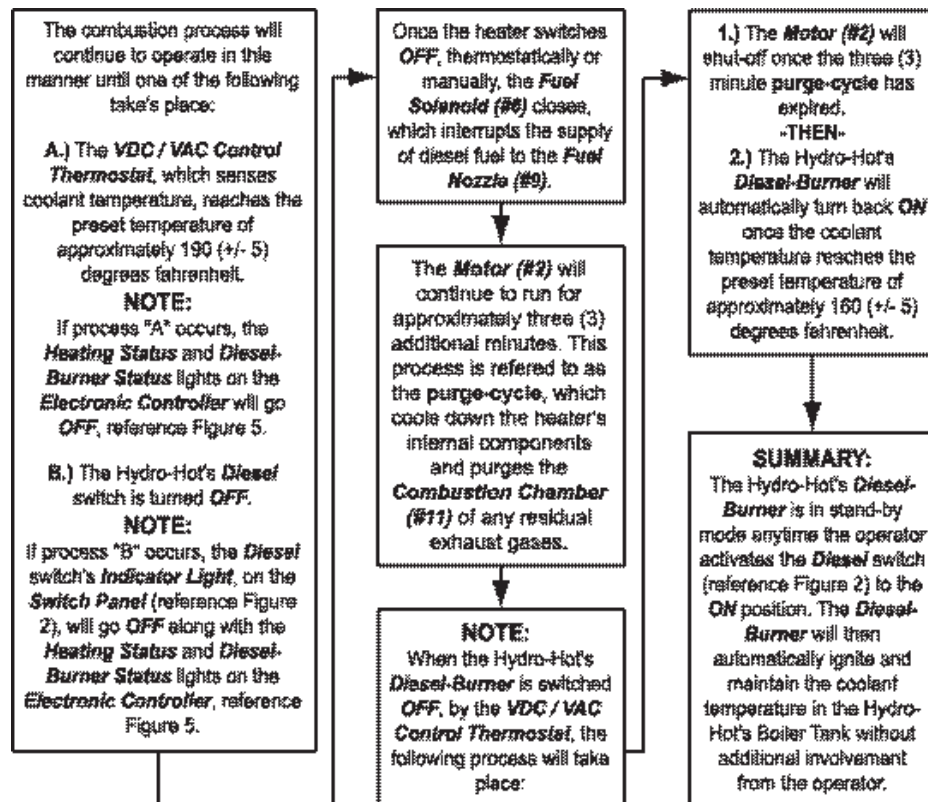

SECTION 2: OPERATING INSTRUCTIONS

Important Information



2.7 Precautions

WARNINGS:

- The Hydro-Hot's Exhaust is HOT!
- DO NOT park in areas where dry conditions exist underneath the vehicle, as a fire may result (i.e. in a dry grassy field for example).
- DO NOT operate the Hydro-Hot's Diesel-Fired Burner inside an enclosed building.
- The Heater should be switched OFF when refueling.

CAUTION: DO NOT operate the Diesel-Burner and/or the Electric Heating Element without the water and antifreeze solution in the Hydro-Hot's Boiler Tank. Failure to do so will cause serious damage to the Heater.

Page 12

SECTION 3: MAINTENANCE

Upkeep



3.1 Maintenance Schedule

Monthly

Check the Hydro-Hot's solution of water and antifreeze to ensure that it is at the proper level. Do this by visually checking the coolant level in the Hydro-Hot's Expansion Tank, reference Figure 1A. Please note that the coolant level should be checked only when the Hydro-Hot is at maximum operating temperature (i.e. when the Diesel-Burner cycles OFF), "HOT."

WARNING: When the Hydro-Hot is at maximum operating temperature (HOT), DO NOT loosen the Radiator Cap. If removed, scalding by hot vapor or coolant could result.

NOTE: This Hydro-Hot product utilizes a Propylene Glycol (P.G.) based water and antifreeze solution. This P.G. based solution is a Boiler type antifreeze, which is Generally Recognized as Safe ("GRAS") by the FDA. For additional information regarding this GRAS antifreeze product, please contact us at 1-800-685-4298 or visit our website at www.vehiclesys.com.

If the coolant needs replenishing, fill the Hydro-Hot's Expansion Tank to the FULL HOT level mark. Be sure to use a 50/50 mixture of water and (P.G.) antifreeze.

Page 13

SECTION 3: MAINTENANCE

■ Upkeep, continued



Annually

WARNING: Before cleaning or servicing, disconnect all power supplies.

To keep your Hydro-Hot running smoothly, it is ideal to have the Diesel-Burner tuned-up annually. A tune-up should consist of a new Fuel Nozzle and Fuel Filter, along with a thorough cleaning of the Combustion Chamber, if necessary (reference Figure 4). To ensure maximum Diesel-Burner performance, always use the recommended Fuel Nozzle (i.e. 0.35 GPH) and Fuel Filter (i.e. 10 Micron) when replacing these parts. Reference the Hydro-Hot "Parts Manual" for spare parts information. If detailed replacement instructions are needed, please reference the Hydro-Hot "Shop Manual" for your specific model of Hydro-Hot, or contact our Technical Department at 1-800-685-4298 for the nearest Hydro-Hot Service Center.

CAUTION: DO NOT operate the Diesel-Burner and/or the Electric Heating Element without the water and antifreeze solution in the Hydro-Hot's Boiler Tank. Failure to do so will cause serious damage to the Heater.

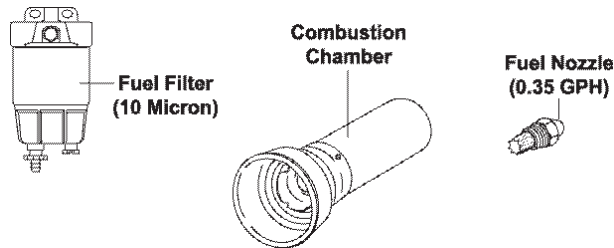

Figure 4

Page 14

SECTION 4: WINTERIZATION

■ Storage

4.1 Domestic Hot Water System

The Hydro-Hot's Domestic Hot Water Heating System must be completely drained of domestic water any time the heater is stored where freezing temperatures may be experienced.

CAUTION: Not winterizing your Hydro-Hot, when freezing temperatures are present, will result in serious damage to the Hydro-Hot's Domestic Hot Water Heating System.

NOTE: The Hydro-Hot can still be used for interior zone heating even if the domestic hot water system has been drained and winterized.

Please follow the instructions listed below when winterizing the Hydro-Hot's Domestic Hot Water Heating System:

A. Completely drain the fresh water storage tank.

NOTE: If your motorhome is equipped with appliances that use fresh water (i.e. ice makers, water purifiers, etc.) follow the manufacturer's recommendation for winterization.

B. Disconnect the domestic water demand pump's suction line from the fresh water storage tank.

Page 15

SECTION 4: WINTERIZATION

■ Storage, continued

- C. Attach an adequate piece of hose onto the suction side of the domestic water demand pump.
- D. Place the opposite end of the hose into an adequate supply of FDA approved RV-Antifreeze.
- E. Open / close all interior and exterior water faucets, one at a time, until only pure RV-Antifreeze is present. Perform this procedure for both the hot and cold faucets.
- F. Remove the hose and reconnect the domestic water demand pump's suction line to the fresh water storage tank.
- G. Disconnect all electrical power supplies to the Hydro-Hot during storage.

NOTE: For de-winterization, completely fill the fresh water storage tank. Open / close all interior and exterior water faucets, one at a time, until only clear water is present / visible.

CAUTION: If you're disinfecting your potable water system, after de-winterizing, be sure to follow RVIA's "Instruction for Disinfection of Potable Water Systems on Recreation Vehicles." These instructions can be found in the ANSI A119.2 Handbook for Recreational Vehicle Standards. To receive a copy of this RVIA Standard, write to: Recreation Vehicle Industry Association, 1896 Preston White Drive, P.O. Box 2999, Reston, VA 20195-0999, or visit the RVIA website at www.rvia.com.

SECTION 5: TROUBLESHOOTING

■ General Information

5.1 General Information

If the Hydro-Hot's Diesel switch "Indicator Light" does not illuminate, and the Diesel-Burner is not functioning, locate the Electronic Controller (Figure 5) and check the following:

- A. Check the Hydro-Hot's Electronic Controller for any RED lights indicating a fault condition. Reference Figure 5 and the Electronic Controller Troubleshooting section to identify these fault conditions.
- B. Check for loose wire connections on the Electronic Controller's Plug terminals. When checking for loose plug terminals, remove the Electronic Controller Faceplate by unscrewing the four cover screws.
- C. Remove the Hydro-Hot's Access Cover and check for loose plug connectors on the Diesel-Burner's Control Unit (located on the under side), see Figure 1A.
- D. Check to ensure that the vehicle's fuel tank has a sufficient level of fuel.
- E. If your Hydro-Hot still fails to operate, please contact our Technical Support Department at 1-800-685-4298 for additional troubleshooting assistance or visit our website at www.hydro-hot.com.

SECTION 5: TROUBLESHOOTING

Electronic Controller

5.2 Electronic Controller Diagnostic

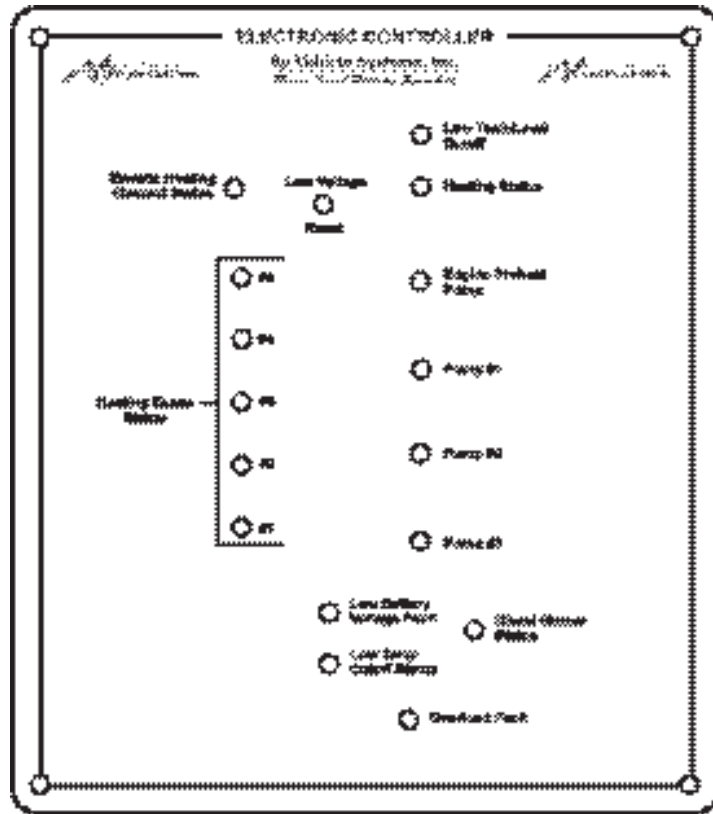

Figure 5

Page 18

SECTION 5: TROUBLESHOOTING

Electronic Controller, continued

Low Tank-Level Cutoff Indicator Light:

This indicator light will illuminate RED when either the 120 VAC Electric Heating Element and/or Diesel-Burner have automatically shutdown due to a low water and antifreeze solution level inside the Hydro-Hot's Boiler Tank. This fault will automatically reset when the low level condition is corrected.

Low Battery Voltage Fault Indicator Light:

This indicator light will illuminate RED whenever the VDC voltage level is too low for the Hydro-Hot to operate properly. This fault must be manually reset after the voltage level has been restored to the VDC battery system, see Low Voltage Reset below.

Low Voltage Reset (Button):

The Hydro-Hot's Electronic Controller must be manually reset whenever the Low Battery Voltage Fault indicator light has been activated. To reset the Electronic Controller, simply depress the "Low Voltage Reset" button located on the Electronic Controller (use a thin straight object to access the reset button through the small hole in the Faceplate).

Overload Fault Indicator Light:

This indicator light will illuminate RED whenever one of the following conditions have occurred:

1. The Hydro-Hot is off due to an electrical overload (i.e. short) in the main VDC power supply circuitry.
2. The Hydro-Hot is off due to a combination of high electrical VDC power loads and a high surface temperature of the Electronic Controller.

Page 19

SECTION 5: TROUBLESHOOTING

Electronic Controller, continued

The Hydro-Hot will automatically restart once the electrical overload (i.e. short) and/or high heat condition is corrected.

Heating Zones Status Indicator Lights:

These five indicator lights (separately) will illuminate GREEN whenever a Zone Thermostat, for each particular zone, is calling for heat. The GREEN indicator lights also indicate that VDC power is being supplied to the particular interior heating zone's Heat Exchangers (i.e. fan motors). If any of the five indicator lights illuminate RED, it indicates that an electrical overload condition (i.e. short) has occurred in a particular heating zone's circuitry.

NOTE: A short in either a heating zone's Interior Room Thermostat or heating zone's Heat Exchanger circuit, will cause the indicator light to illuminate RED.

Pumps #1, #2, and #3 Indicator Lights:

These indicator lights (separately) will illuminate GREEN whenever a Circulation Pump is operating. If any of the three indicator lights illuminate RED, it indicates that an electrical overload condition (i.e. short) has occurred in the particular component's circuitry.

NOTE: The Zone Circulation Pumps #1 and #2 are activated whenever a Zone Thermostat calls for heat. Pump #3 / Stir Pump is activated whenever the Domestic Water is being used on a continuous basis.

SECTION 5: TROUBLESHOOTING

Electronic Controller, continued

Engine Preheat Pump Indicator Light: (HHE-200 Model Only)

This indicator light will illuminate GREEN whenever the Engine Preheat Pump is operating. Please note that this light will only be active if the Engine Preheat switch is ON in conjunction with either the Diesel and/or the Electric switch. If this indicator light illuminates RED, it indicates an electrical overload condition (i.e. short) has occurred in this particular component's circuitry.

Heating Status Indicator Light:

This indicator light will illuminate GREEN whenever the Hydro-Hot's VDC / VAC Control Thermostat is calling for heat, allowing the water and antifreeze solution in the Hydro-Hot's Boiler Tank to be heated by either the Diesel-Burner and/or the Electric Heating Element. When this indicator light is off, no heat is being supplied to the Hydro-Hot's Boiler Tank.

NOTE: The Hydro-Hot's VDC / VAC Control Thermostat will automatically activate the Diesel-Burner and/or the Electric Heating Element, only if the Diesel and/or Electric switch is in the ON position. So to heat your motorhome / domestic hot water, simply choose the desired heat source(s) and leave the switch(s) (i.e. Diesel and/or Electric) ON.

Electronic Controller, continued

Electric Heating Element Status Indicator Light:

This indicator light will illuminate GREEN whenever the Hydro-Hot's Electric Heating Element is operating and providing heat to the Hydro-Hot's Boiler Tank. Please note that this light will only be active if the Electric switch is in the ON position. If this indicator light illuminates RED, it indicates an electrical overload condition (i.e. short) has occurred in the Electric Heating Element's VDC powered circuitry.

WARRANTY INFORMATION

- FOR HYDRO-HOT MODELS -

Vehicle Systems Inc. warrants the HYDRO-HOT Heater to be free from defects in material and workmanship under normal use and service for a period of two (2) years on both parts and labor commencing upon the original date of registration of the vehicle. The warranty period may not however, exceed 36 months from the original date of delivery by Vehicle Systems, Inc. Replacement parts are warranted for the remainder of the Heater's standard warranty period or for six months (180 days), whichever is greater.

This warranty is conditional upon proper use of the Heater by the end-user. This warranty does not apply to damage or failure of the HYDRO-HOT Heater, or the vehicle into which it was installed, due to improper installation, assembly, maintenance, abuse, neglect, accident, or the use of parts not supplied by Vehicle Systems Inc. Vehicle Systems is not responsible for incidental or consequential damages.

The intent of this warranty is to protect the end-user of the heating system from such defects, which would occur in the manufacture of the product. The warranty is not intended to protect the end-user from problems, which are outside the ability of Vehicle Systems' control.

To obtain warranty repair authorization or for additional product information, please contact our Technical Support Department at 1-800-685-4298 (8 AM to 5 PM Mountain Standard Time).

OWNER'S SERVICE LOG:

Date	Service Performed	Service Center

(Continued) **OWNER'S SERVICE LOG:**

Date	Service Performed	Service Center

Vehicle Systems

I N C O R P O R A T E D

Motor Coach Heating Specialists • Manufacturers and Distributors

15549 East Highway 52 • Fort Lupton, Colorado 80621 • 1-800-685-4298 • Fax: 303-857-9000

© Copyright 2003 Vehicle Systems, Inc. All rights reserved

www.vehiclesys.com

LTE-VHS-224