



# Aqua-Hot<sup>®</sup>

HYDRONIC HEATING SYSTEM

## 375-D



# AHE-375-D03 PARTS MANUAL



# Table of Contents

## **Section 1: Heater Overview**

---

General ..... Page 5  
Top ..... Page 6-7  
Front ..... Page 8-11  
Check Valves ..... Page 12  
Mixer Valve Assembly ..... Page 13  
Combustion Chamber ..... Page 14

## **Section 2: Diesel-Burner**

---

Overview ..... Page 15-16

## **Section 3: Misc. Parts**

---

Misc. Parts & Tools ..... Page 17



## SECTION 1: HEATER OVERVIEW - GENERAL

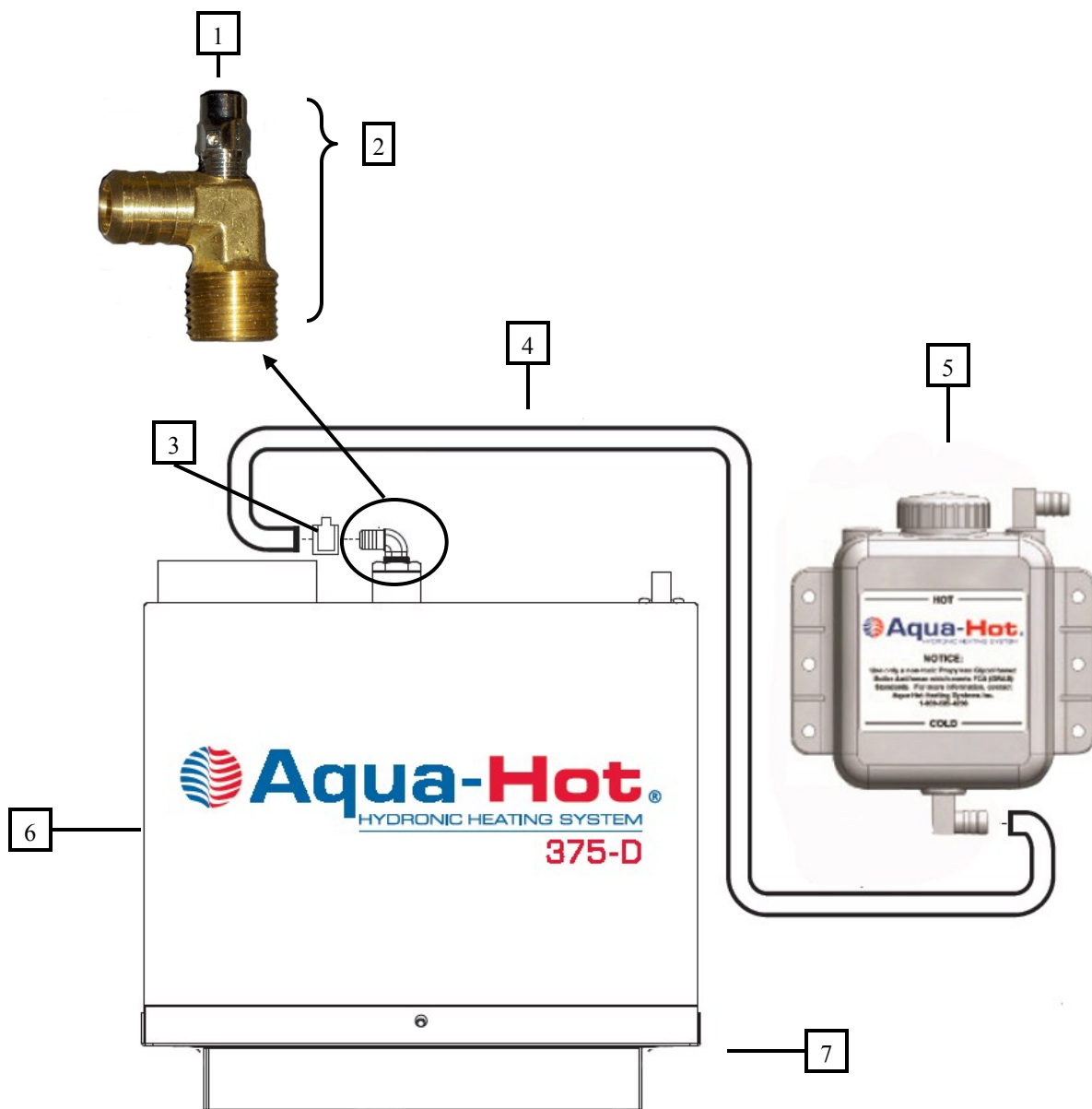

Key	Part Number	Description
1	PLX-007-065	Valve, Air Comb, Coin/Key
2	PLE-007-000	Valve, Air Assembly Comb, Coin/Key
3	PLX-CTB-250	Clamp, Hose Constant Tension, 23/32 in
4	PLE-210-192	Tube, Over Flow Clear 5/8 in x 8 ft
5	PLE-063-401	Tank 3 QT. Expansion w/ 5/8 in barbs
6	SME-700-180	Cover, Access
7	SME-700-802	Tray, Mounting, Assembly

# SECTION 1: HEATER OVERVIEW - TOP

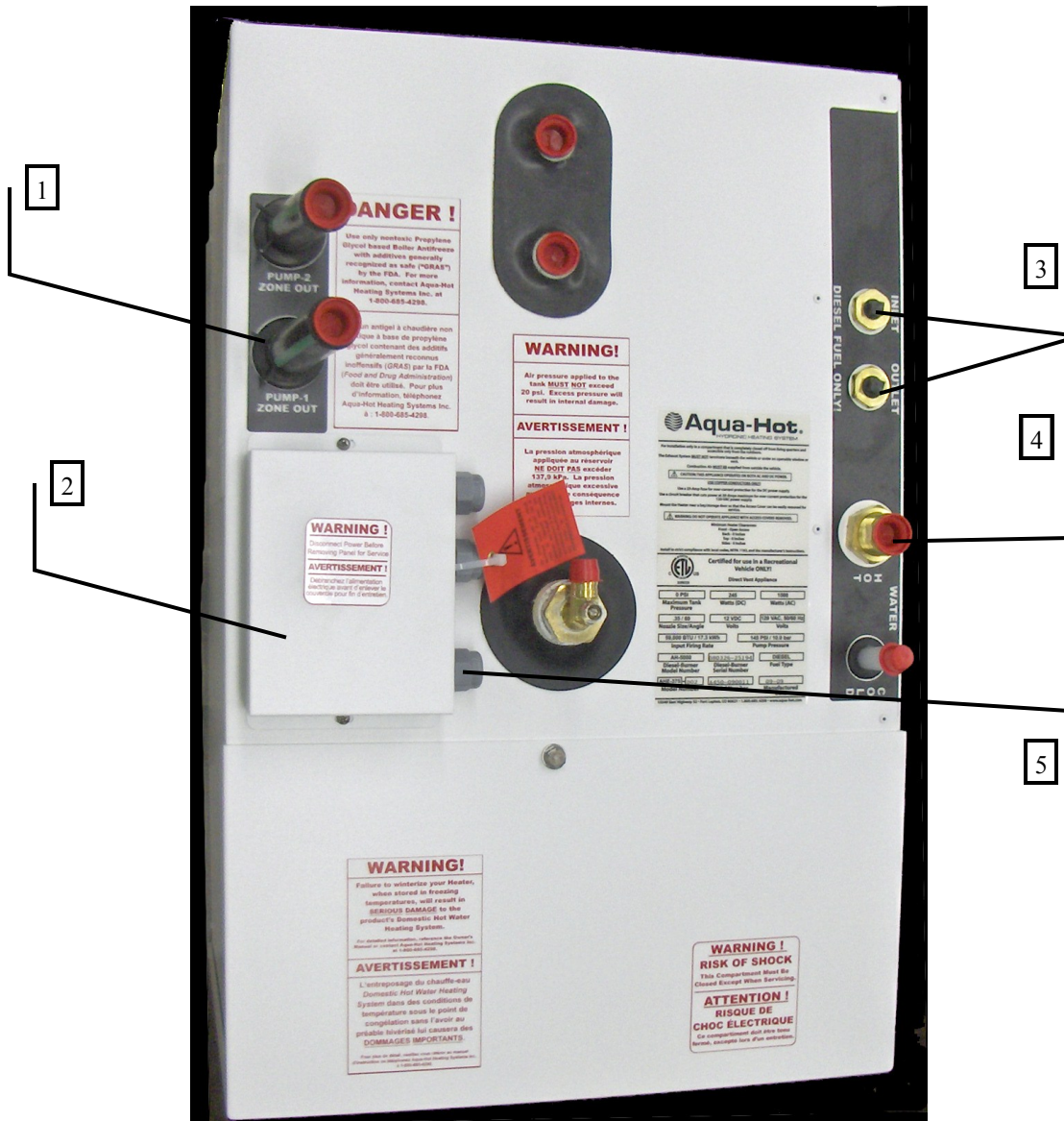

Key	Part Number	Description
1	PLX-CTB-270	Clamp, Hose Constant Tension 7/8 in
2	SME-900-205	Cover, top/back/side assembly
3	PLX-105-800	Fitting, Bulkhead, 1/4 x 1/4 in (F) NPT Brass
4	PLE-105-810	Fitting, Bulkhead Mod 1/2 x 1/2 (F)
5	HDX-000-623	Clamp, Romex 1/2" Plastic

**SECTION 1: HEATER OVERVIEW - TOP**

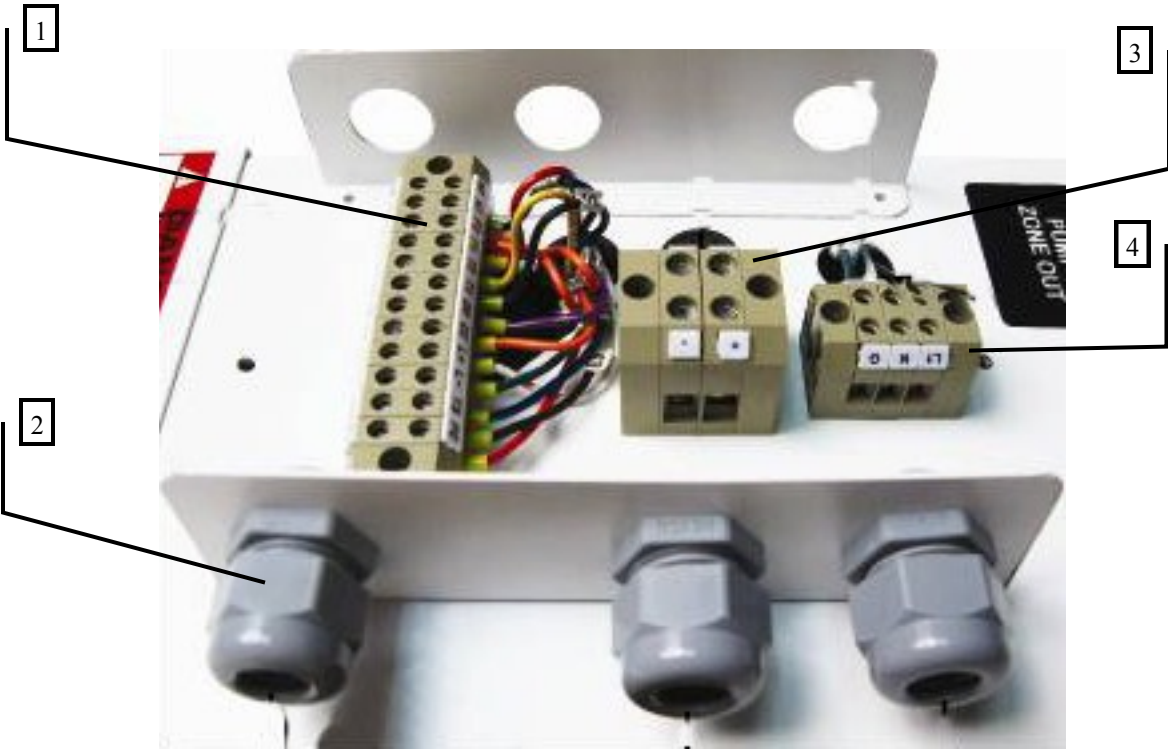

Key	Part Number	Description
1	ELE-000-911	Block, Terminal 12 Position 22-12 AWG
2	HDX-000-623	Clamp, Romex 1/2" Plastic
3	ELE-000-900	Block, Terminal 2 Position 22-8 GA
4	ELE-000-905	Block Terminal 3 Position 22-8 GA

## SECTION 1: HEATER OVERVIEW - FRONT

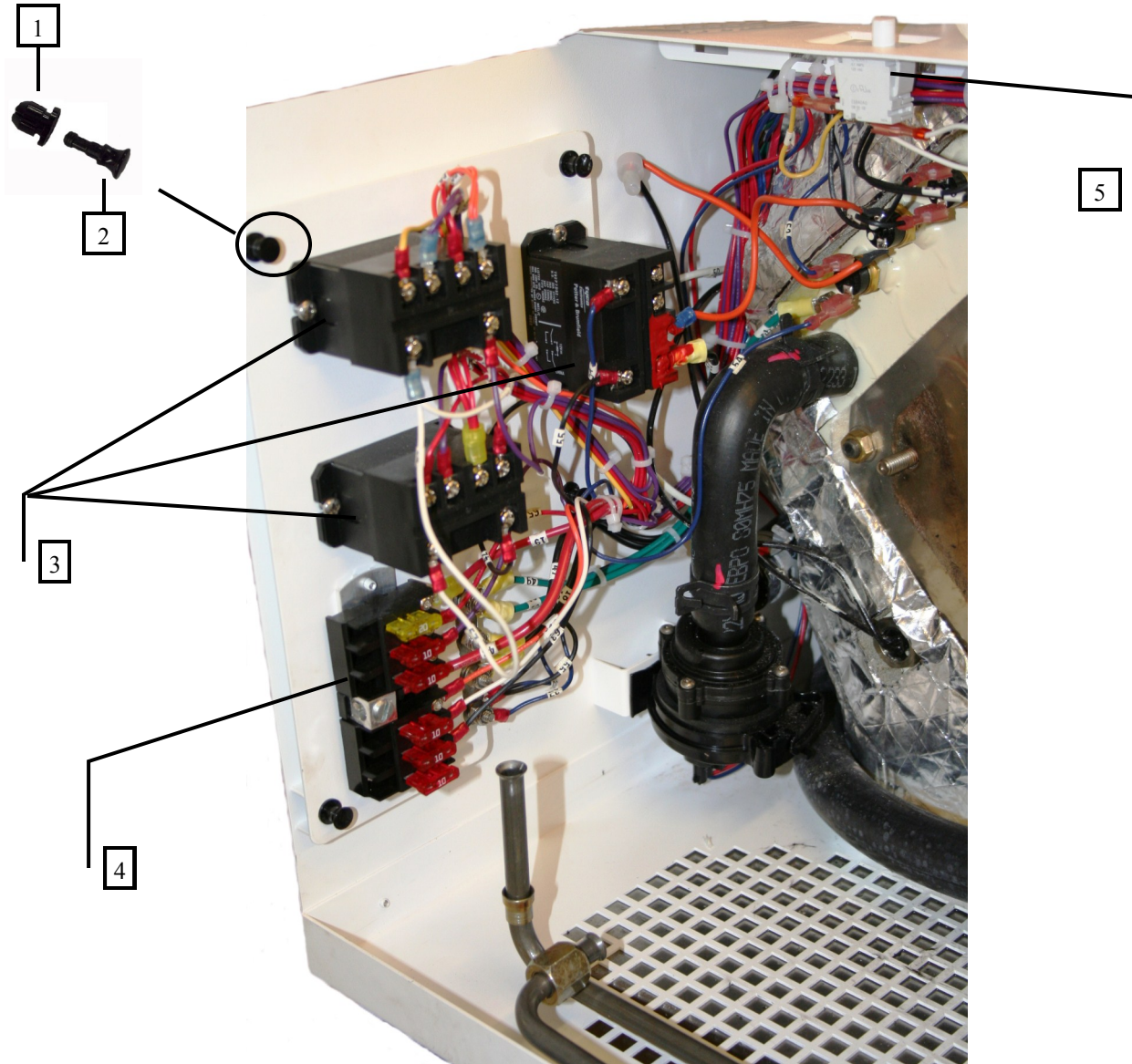

Key	Part Number	Description
1	HDX-100-100	Grommet, Nylatch
2	HDX-100-200	Plunger, Nylatch,
3	ELX-630-001	Relay, 30A 277 VAC 12VDC Coil
4	ELX-BB6-10A	Fuse Block
5	ELX-000-050	Switch, Interlock



## SECTION 1: HEATER OVERVIEW - FRONT

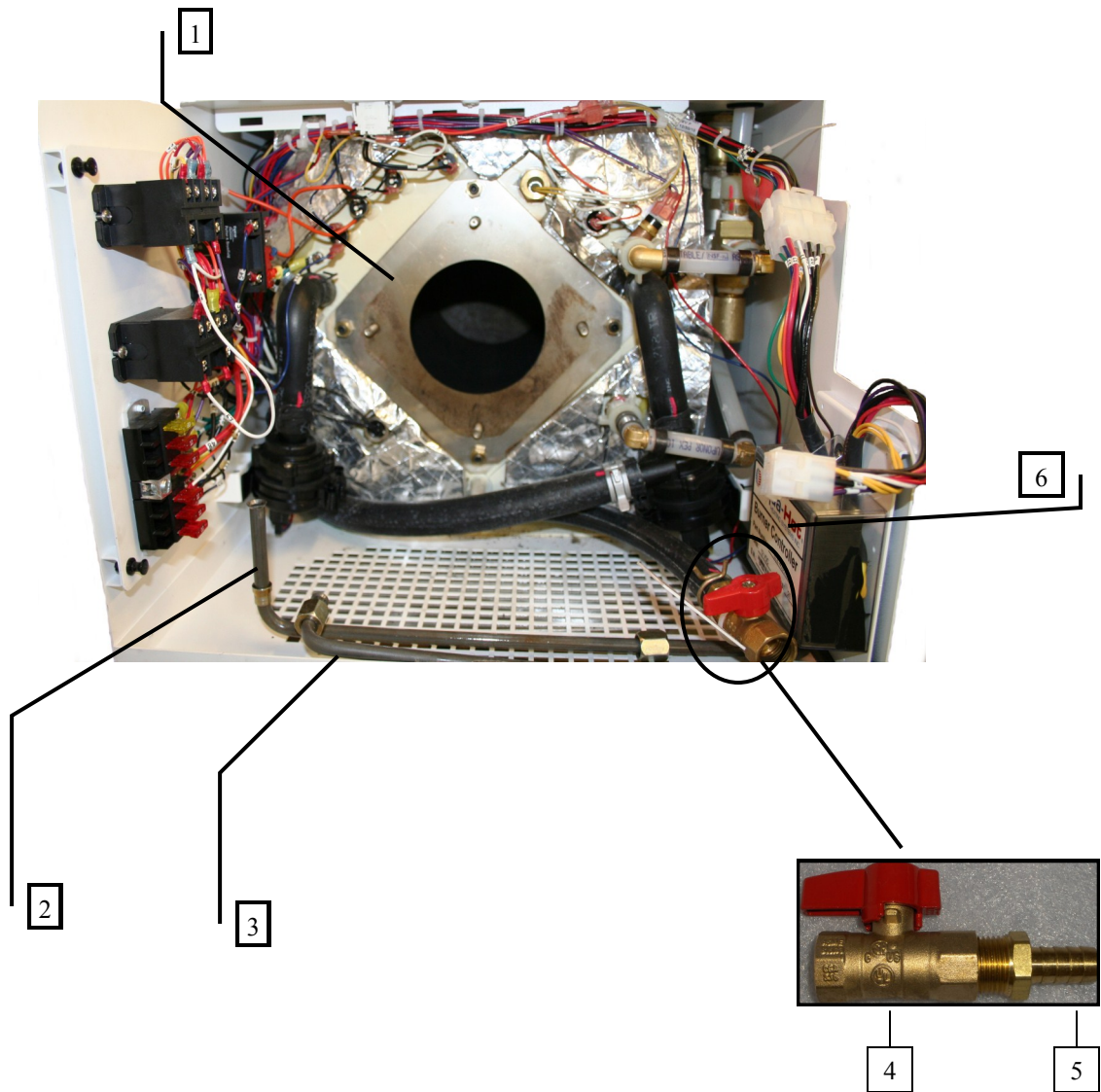

Key	Part Number	Description
1	SME-700-280	Space, Flame Tube 6 in
2	FLE-421-857	Fuel Line, Supply Assembly 3/8 in Steel,
3	FLE-421-856	Fuel Line, Return Assembly 3/8 in Steel
4	PLX-BV1-200	Valve, Ball 1/2 in (F) NPT Brass
5	PLX-699-330	Fitting, Brass Barb 1/2 X 1/2 (M) NPT
6	ELE-400-202	Module, Burner Assembly

## SECTION 1: HEATER OVERVIEW - FRONT

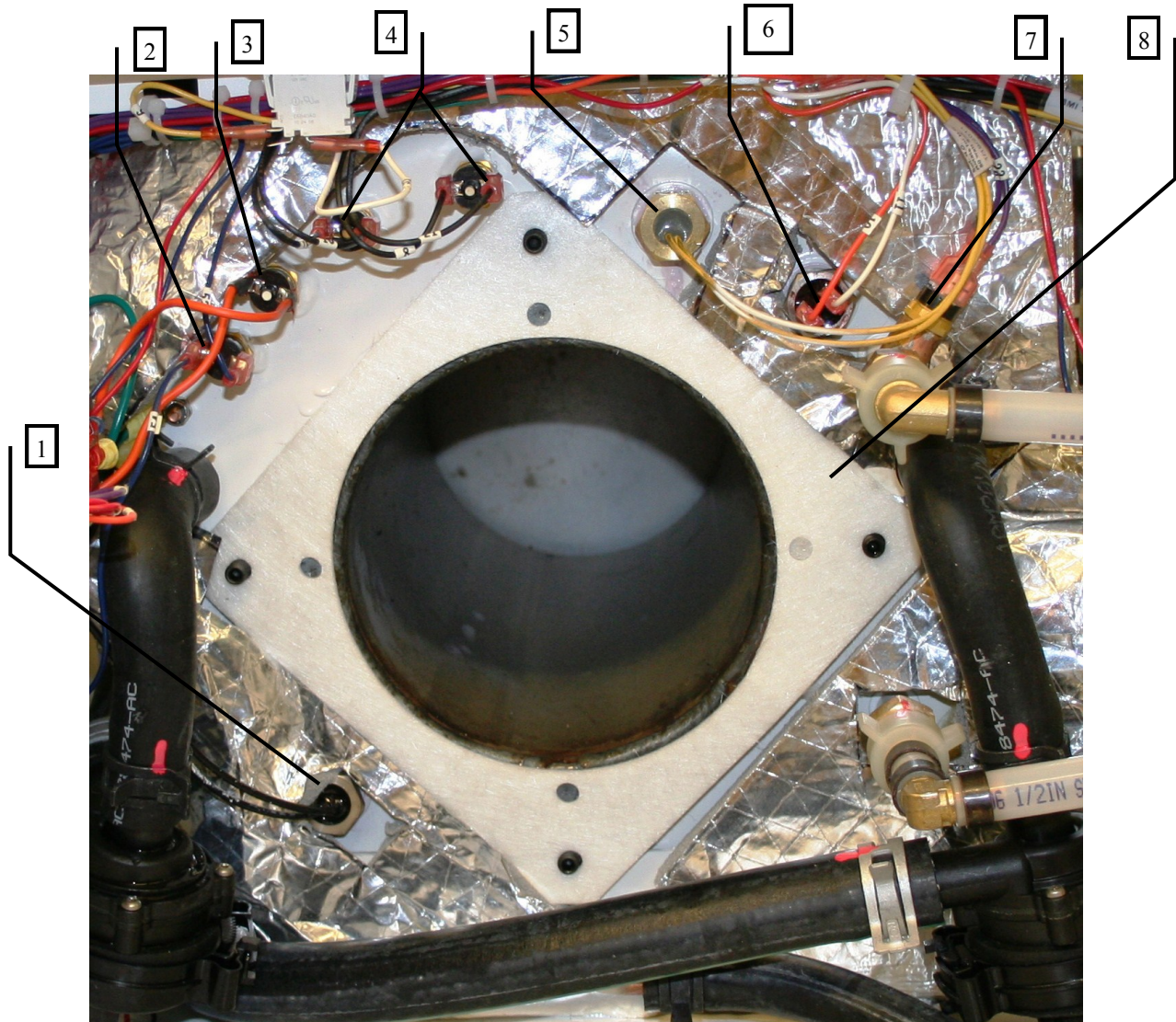

Key	Part Number	Description
1	ELE-207-500	Element, Electric Heating Cartridge, Immersion 120v 1500 Watt
2	ELE-800-108	Thermostat, Control VAC 185° F
3	ELE-HLT-424	Thermostat, High Limit VAC 215° F
4	ELE-HLT-425	Thermostat, High Limit 215°F
5	ELE-800-002	Switch Fluid Level Brass w/Connectors
6	ELE-014-005	Thermostat, Control 185°F 1/2 in (M) NPT
7	ELE-LTC-608	Thermostat, Low Temp Cut-Off w/Spade Connectors
8	HDE-700-205	Gasket, Combustion Chamber Tube

## SECTION 1: HEATER OVERVIEW - FRONT

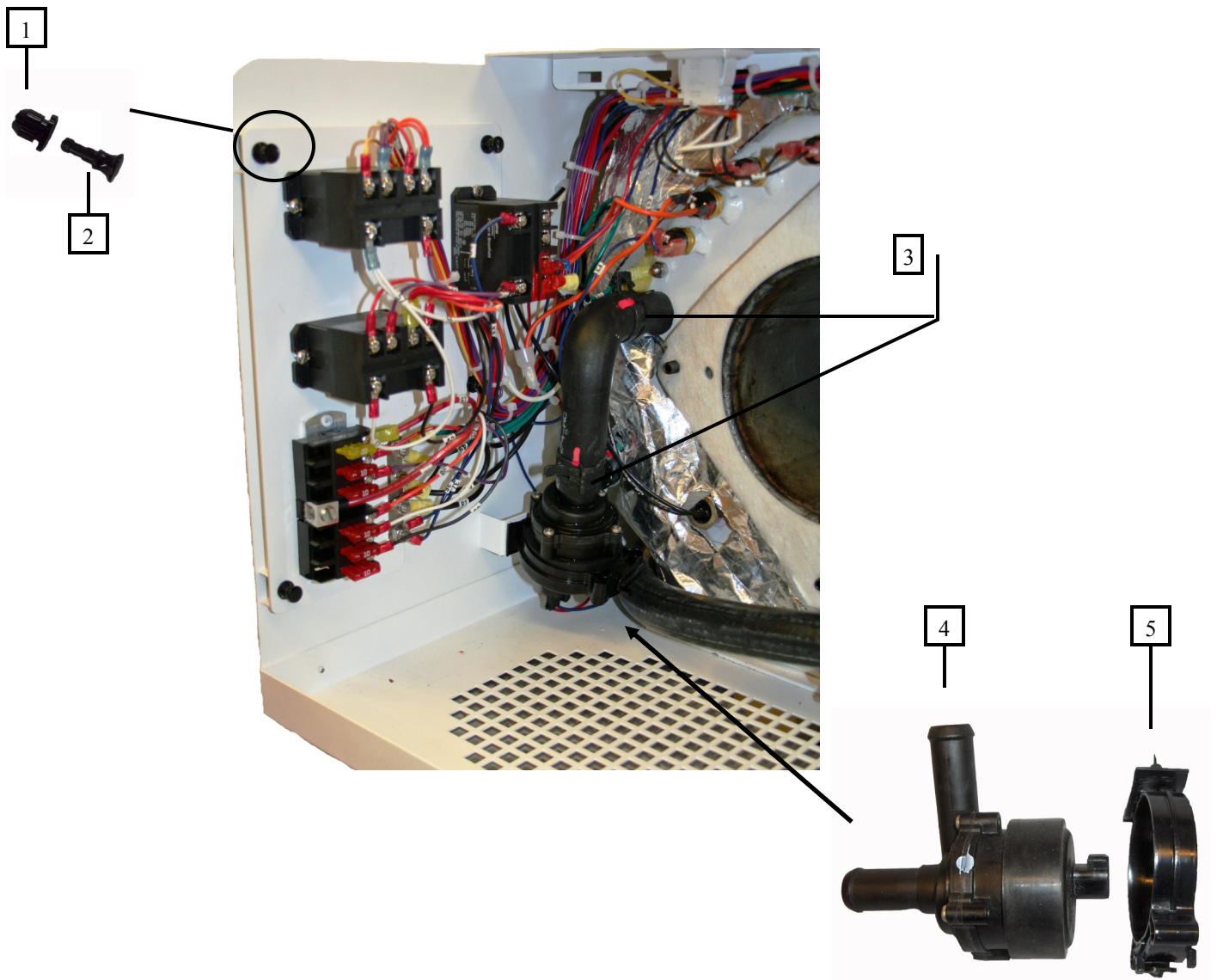

Key	Part Number	Description
1	HDX-100-100	Grommet, Nylatch
2	HDX-100-200	Plunger, Nylatch
3	PLX-CTB-270	Clamp, Hose, Constant Tension, 3/4, AH/HH
4	PLX-100-835	Pump, Cooper Standard
5	PLX-100-836	Bracket, Cooper Pump Mounting

## SECTION 1: HEATER OVERVIEW - CHECK VALVES

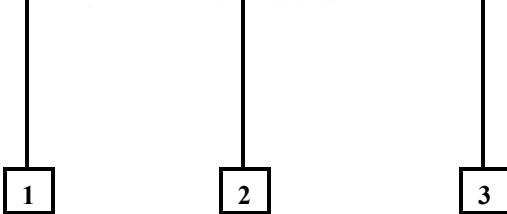
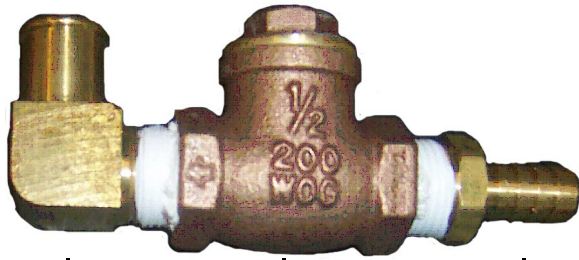

Key	Part Number	Description
1	PLX-A65-300	Fitting, Brass, Elbow, 90°, Barb 3/4 x 1/2 (M) NP
2	PLX-2A1-300	Valve, Brass Check, 1/2 X 1/2 (F)NPT
3	PLX-A65-200	Fitting, Brass, Barb, 3/4 X 1/2 (M)NPT
4	PLX-CTB-290	Clamp, Hose Band 1-1/16 in dia.

## SECTION 1: HEATER OVERVIEW - MIXER VALVE ASSEMBLY

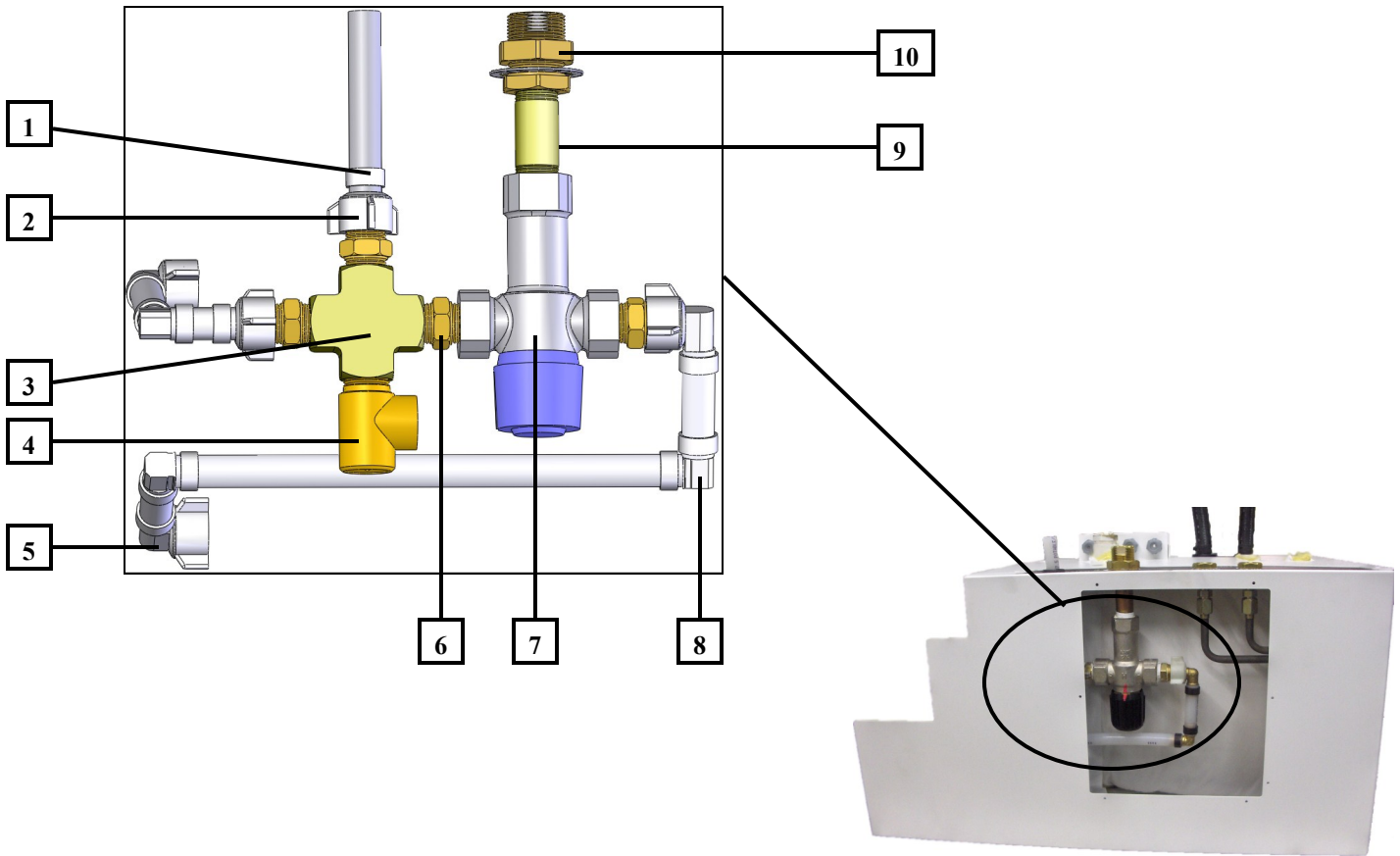

Key	Part Number	Description
1	PLX-000-745	Ring, Crimp 1/2 in
2	PLX-000-730	Fitting, Straight, Swivel 1/2 in Barb x 1/2 in FPT
3	PLX-000-725	Fitting, Cross 1/2 in Brass
4	PLX-111-125	Valve, Pressure Relief 125 PSI
5	PLX-000-755	Fitting, Elbow, Swivel 1/2 in Barb x 1/2 in FPT
6	PLX-122-000	Fitting, Brass, Close Nipple 1/2 (M)NPT w/Hex
7	PLX-09P-100	Valve, Tempering 145°F
8	PLX-000-750	Fitting, Elbow, 1/2 in Barb
9	PLX-113-250	Fitting, Nipple 1/2 in NPT x 2-1/2 in Brass
10	PLE-105-810	Fitting, Bulkhead Mod 1/2 x 1/2 (F)

## SECTION 1: HEATER OVERVIEW - COMBUSTION CHAMBER

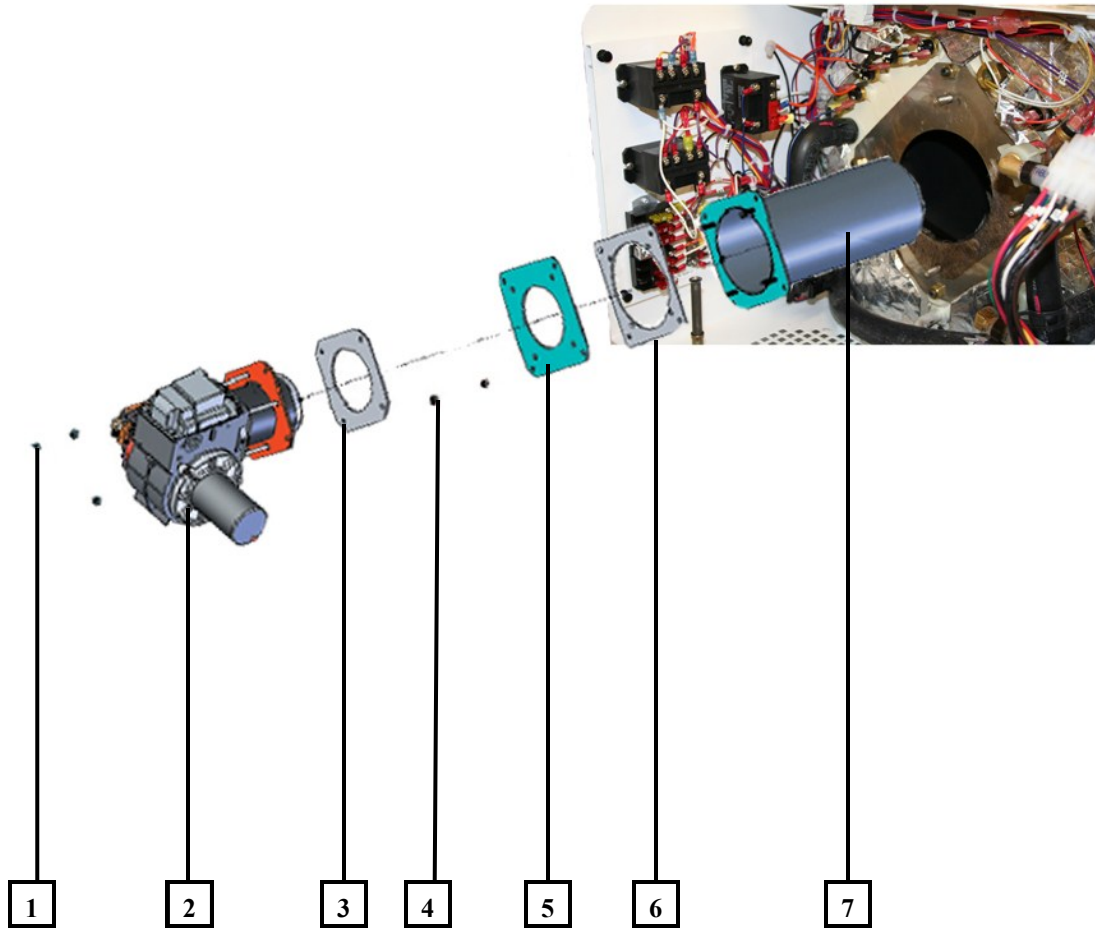

Key	Part Number	Description
1	HDX-080-231	5/16-18 Heavy Duty Nuts
2	BPE-400-002	Burner, AH-5000 Diesel-Burner
3	HDE-700-200	Gasket, Diesel Burner
4	HDX-080-230	5/16-24 Brass Nuts
5	SME-700-280	Spacer, Flame Tube 6 in
6	HDE-700-205	Gasket, Combustion Chamber Tube
7	SME-700-285	Chamber, Combustion 6 in x 13-5/8 in Tube

## SECTION 2: DIESEL BURNER

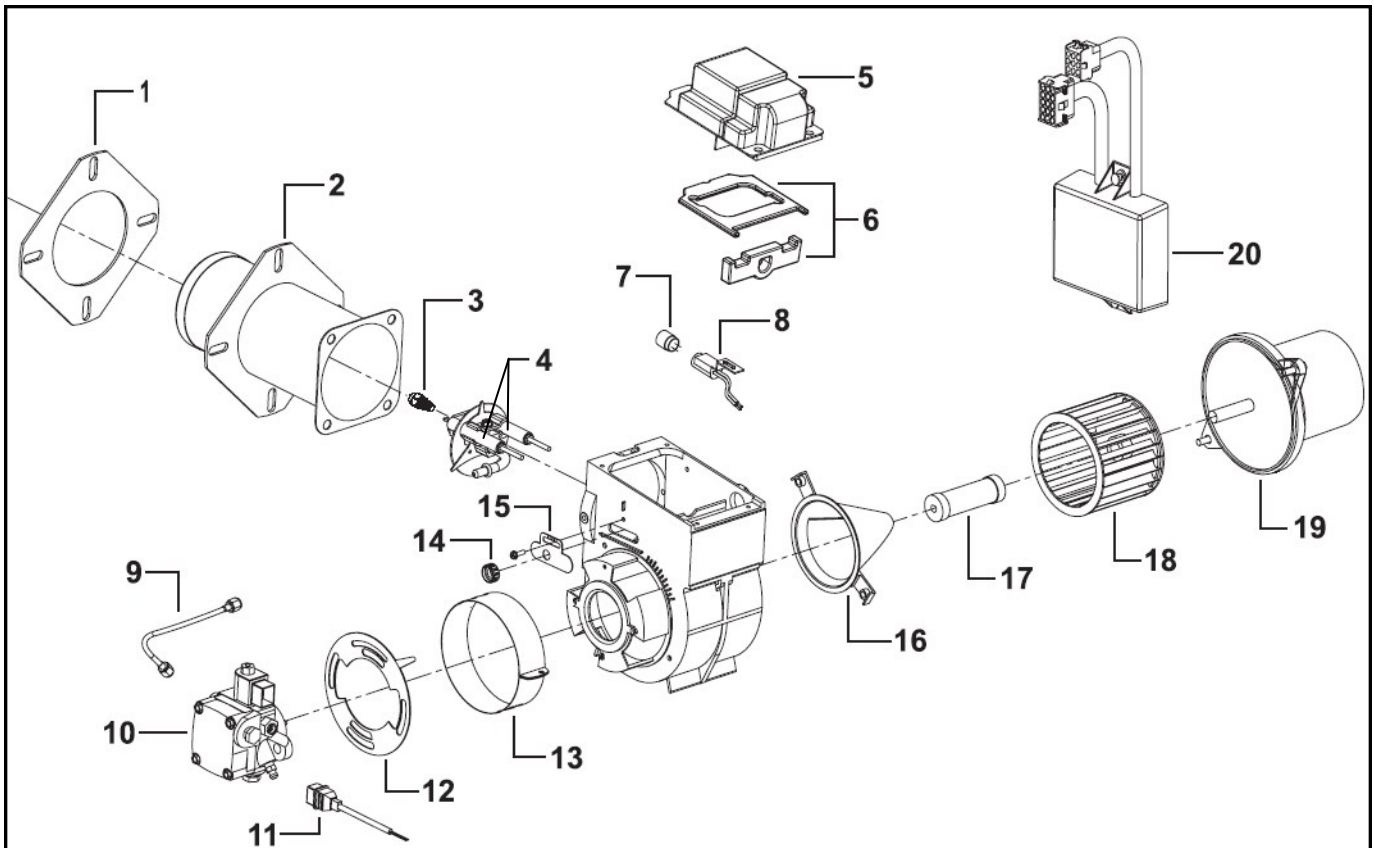

Key	Part Number	Description
1	HDE-700-200	Diesel Burner Mounting Gasket
2	BPE-700-210	Air-Tube Assembly
3	WPX-886-41A	Nozzle, Fuel
4	ELX-375-005	Igniter Assembly
5	BPE-700-211	Ignition Module Assembly
6	BPE-700-213	Ignition Module Gasket Kit
7	BPE-700-214	Flame Sensor Cad Cell Assembly
8	BPE-700-215	Flame Sensor Socket
9	BPE-700-216	Fuel-Supply Tube Assembly
10	BPE-700-217-FRU	Fuel Pump Assembly and Mounting Gasket Kit
11	BPE-700-218	Cord-Set
12	BPE-700-219	Air Shutter
13	BPE-700-220	Air Band
14	BPE-700-221	Nut, Plate
15	BPE-700-222	Plate
16	BPE-700-223	Air Guide
17	BPE-700-224	Coupling
18	BPE-700-225	Blower Wheel
19	BPE-700-226-FRU	Blower Motor and Mounting Gasket Kit
20	ELE-400-202	Diesel-Burner Controller, Modified

## SECTION 2: DIESEL BURNER

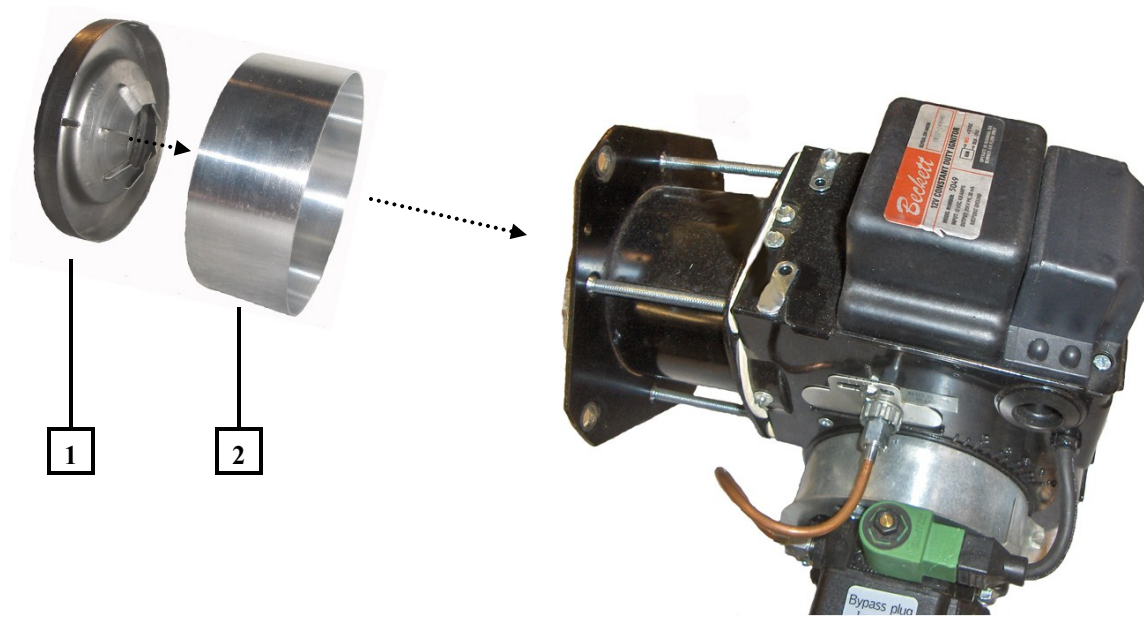

Key	Part Number	Description
1	BPE-700-240	Diffuser, Modified
2	BPE-700-235	Ring, Inlet .040 Wall Aluminum



## SECTION 3: MISC. PARTS & TOOLS

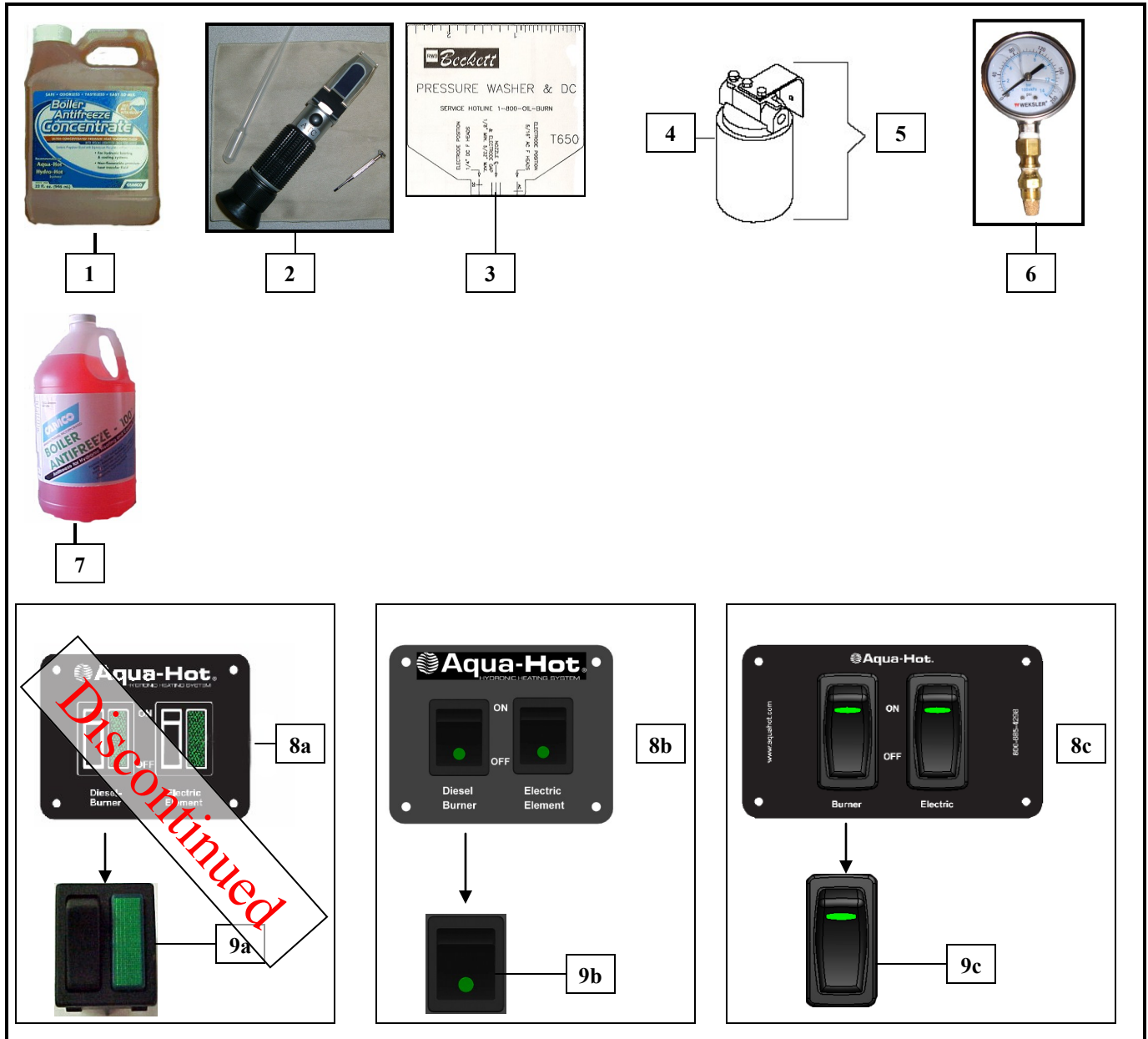

Key	Part Number	Date Of Use	Description
1	MSX-300-275		Antifreeze, Boiler, P.G., 1 qt, Concentrate, (Camco)
2	MSX-907-162		Tester, Refractometer, Battery/Coolant
3	ELX-375-006		Gauge, Beckett, Ignition Electrode
4	FLE-120-100		Filter, Canister, Replacement, Garber
5	FLX-120-000		Filter, Fuel, Garber
6	WPE-600-190		Gauge, Fuel Pressure
7	MSX-300-270		Antifreeze, Boiler, P.G, 1 Gallon (Camco)
8a	ELE-000-506	09/209 - 09/2010	Switch, 2-Postion Assembly, LED - OBSOLETE
8b	ELE-000-506	09/209 - 08/2011	Switch, 2-Postion Assembly, LED
8c	ELE-000-508	09/2011 - Current	Switch, 2-Postion Assembly, LED
9a	ELX-283-284	09/2009 - 09/2010	Switch, Rocker, LED, 12 VDC - OBSOLETE
9b	ELX-283-284	09/209 - 08/2011	Switch, Rocker, LED, 12 VDC
9c	ELX-283-283	09/2011 - Current	Switch, Rocker, LED, 12 VDC







# Aqua-Hot®

HYDRONIC HEATING SYSTEM

## 375-D

# AHE-375-D03

# Parts Manual



**Aqua-Hot®**  
HEATING SYSTEMS INC.

15549 East Highway 52 | Fort Lupton, CO 80621  
Toll free: 800.685.4298 | phone: 303.659.8221 | fax: 303.857.7881  
[www.aquahot.com](http://www.aquahot.com)